

Neosys Technology Inc.

Nuvo-7501 Series

User Manual

Revision 1.1

Table of Contents

Table of Contents	2
Legal Information	4
Contact Information	5
Declaration of Conformity	5
Copyright Notice	6
Safety Precautions	7
Hot Surface Warning	7
Battery Warning	7
Service and Maintenance	8
ESD Precautions	8
Restricted Access Location	8
About This Manual	9
1 Introduction	
1.1 Product Specifications.....	11
1.1.1 Nuvo-7501 Specifications	11
1.1.2 Nuvo-7505D Specifications.....	13
1.2 Dimension	15
1.2.1 Top View of Nuvo-7501 Series.....	15
1.2.2 Front View of Nuvo-7501 Series	15
1.2.3 Back View of Nuvo-7501 Series.....	16
1.2.4 Side View of Nuvo-7501 Series	16
2 System Overview	
2.1 Nuvo-7501/ 7505D Series Packing List.....	17
2.2 Front Panel I/O	18
2.2.1 Power Button	19
2.2.2 Ethernet Port.....	20
2.2.3 Reset Button	21
2.2.4 DVI Port	21
2.2.5 VGA Port.....	22
2.2.6 System Status LED.....	22
2.2.7 4-Pole 3.5mm Microphone-in/ Speaker-out Jack	23
2.2.8 CMOS Reset Button	23
2.2.9 USB 3.1 Gen1 Port	23
2.2.10 Nuvo-7501 COM Port	24
2.2.11 Nuvo-7505D Isolated COM Port	25
2.2.12 3-Pin Terminal Block for DC Input	26
2.3 Rear Panel DIO Port (Nuvo-7505D Only)	27
2.4 Rear Panel COM Ports (Nuvo-7505D Only)	28
2.5 Internal I/O Functions.....	29
2.5.1 Status LED Output & Remote On/ Off Control	29
2.5.2 M.2 2280 (M Key) Slot for SSD (SATA Signal Only).....	31
2.5.3 Single DRAM SO-DIMM Slot	33
2.5.4 mini-PCIe Slot.....	34
2.5.5 M.2 2242 B Key and SIM Card Slot	36
2.5.6 SATA Port.....	38
2.5.7 Internal USB Port.....	39
3 System Installation	
3.1 Disassembling the System	41
3.2 CPU Installation	43
3.3 DDR4 SO-DIMM Installation.....	48
3.4 M.2 2280 SATA SSD Installation	50
3.5 M.2 Module Installation	52

3.6	mini-PCIe Module Installation	56
3.7	HDD/ SSD Installation	58
3.7.1	2.5" HDD/ SSD Installation	58
3.7.2	3.5" HDD Installation	60
3.8	Installing the System Enclosure	62
3.9	Mounting Nuvo-7501 Series	64
3.9.1	Wall-mounting Nuvo-7501 Series	64
3.9.2	Installing DIN-Rail Mounting Kit (Optional).....	65

4 System Configuration

4.1	BIOS Settings	66
4.1.1	COM Port Configuration.....	67
4.1.2	COM Port High Speed Mode	69
4.1.3	Power On After Power Failure Option	70
4.1.4	SATA Configuration	71
4.1.5	Power & Performance (CPU SKU Power Configuration)	72
4.1.6	Wake on LAN Option	73
4.1.7	Boot Menu	74
4.1.8	Boot Type (Legacy/ UEFI).....	75
4.1.9	Add Boot Options.....	76
4.1.10	Watchdog Timer for Booting.....	77
4.1.11	Legacy/ UEFI Boot Device.....	78

5 OS Support and Driver Installation

5.1	Operating System Compatibility	79
5.2	Driver Installation	80
5.3	Install Drivers Automatically	80
5.4	Install Drivers Manually	81
5.4.1	Windows 10 (x64)	81
5.5	Driver Installation for Watchdog Timer Control.....	81
5.5.1	Windows 10 (x64)	81
5.5.2	Windows 10 (WOW64)	81

Appendix A Using WDT & DIO

Watchdog Timer	82
Isolated DIO (Nuvo-7505D Only)	82
Installing WDT_DIO Library.....	82
WDT Functions.....	85
InitWDT	85
SetWDT	85
StartWDT	86
ResetWDT	86
StopWDT	86
DIO Functions.....	87
InitDIO.....	87
DIReadLine	87
DIReadPort	87
DOWriteLine.....	88
DOWritePort.....	88

Legal Information

All Neosys Technology Inc. products shall be subject to the latest Standard Warranty Policy

Neosys Technology Inc. may modify, update or upgrade the software, firmware or any accompanying user documentation without any prior notice. Neosys Technology Inc. will provide access to these new software, firmware or documentation releases from download sections of our website or through our service partners.

Before installing any software, applications or components provided by a third party, customer should ensure that they are compatible and interoperable with Neosys Technology Inc. product by checking in advance with Neosys Technology Inc.. Customer is solely responsible for ensuring the compatibility and interoperability of the third party's products. Customer is further solely responsible for ensuring its systems, software, and data are adequately backed up as a precaution against possible failures, alternation, or loss.

For questions in regards to hardware/ software compatibility, customers should contact Neosys Technology Inc. sales representative or technical support.

To the extent permitted by applicable laws, Neosys Technology Inc. shall NOT be responsible for any interoperability or compatibility issues that may arise when (1) products, software, or options not certified and supported; (2) configurations not certified and supported are used; (3) parts intended for one system is installed in another system of different make or model.

Contact Information

Headquarters
(Taipei, Taiwan) **Neosys Technology Inc.**
15F, No.868-3, Zhongzheng Rd., Zhonghe Dist., New Taipei City, 23586, Taiwan
Tel: +886-2-2223-6182 Fax: +886-2-2223-6183 [Email](#), [Website](#)

Americas
(Illinois, USA) **Neosys Technology America, Inc.**
3384 Commercial Avenue, Northbrook, IL 60062, USA
Tel: +1-847-656-3298 [Email](#), [Website](#)

China **Neosys Technology China Co., Ltd.**
Room 429 /431, Building 32, Guiping Road 680, Shanghai, 200233, China
Tel: +86-2161155366 [Email](#), [Website](#)

Declaration of Conformity

FCC This equipment has been tested and found to comply with the limits for a Class A digital device, pursuant to part 15 of the FCC Rules. These limits are designed to provide reasonable protection against harmful interference when the equipment is operated in a commercial environment. This equipment generates, uses, and can radiate radio frequency energy and, if not installed and used in accordance with the instruction manual, may cause harmful interference to radio communications. Operation of this equipment in a residential area is likely to cause harmful interference in which case the user will be required to correct the interference at own expense.

CE The product(s) described in this manual complies with all applicable European Union (CE) directives if it has a CE marking. For computer systems to remain CE compliant, only CE-compliant parts may be used. Maintaining CE compliance also requires proper cable and cabling techniques.

Copyright Notice

All rights reserved. This publication may not be reproduced, transmitted, transcribed, stored in a retrieval system, or translated into any language or computer language, in any form or by any means, electronic, mechanical, magnetic, optical, chemical, manual or otherwise, without the prior written consent of Neosys Technology, Inc.

Disclaimer

This manual is intended to be used as an informative guide only and is subject to change without prior notice. It does not represent commitment from Neosys Technology Inc. Neosys Technology Inc. shall not be liable for any direct, indirect, special, incidental, or consequential damages arising from the use of the product or documentation, nor for any infringement on third party rights.

Patents and Trademarks

Neosys, the Neosys logo, Expansion Cassette, MezIO™ are registered patents and trademarks of Neosys Technology, Inc.

Windows is a registered trademark of Microsoft Corporation.

Intel®, Core™ are registered trademarks of Intel Corporation

NVIDIA®, GeForce® are registered trademarks of NVIDIA Corporation

All other names, brands, products or services are trademarks or registered trademarks of their respective owners.

Safety Precautions

Read these instructions carefully before you install, operate, or transport the system.

- Install the system or DIN rail associated with, at a sturdy location
- Install the power socket outlet near the system where it is easily accessible
- Secure each system module(s) using its retaining screws
- Place power cords and other connection cables away from foot traffic. Do not place items over power cords and make sure they do not rest against data cables
- Shutdown, disconnect all cables from the system and ground yourself before touching internal modules
- Ensure that the correct power range is being used before powering the device
- Should a module fail, arrange for a replacement as soon as possible to minimize down-time
- By means of a power cord connected to a socket-outlet with earthing connection
- This product is intended to be supplied by a Listed Power Adapter or DC power source, rated 24Vdc, 16A, Tma 60 degree C and 5000m altitude during operation. If further assistance is required, please contact Neousys Technology
- If the system is not going to be used for a long time, disconnect it from mains (power socket) to avoid transient over-voltage

Hot Surface Warning



HOT SURFACE. DO NOT

TOUCH. "ATTENTION: Surface chaude. Ne pas toucher."

WARNING!

Components/ parts inside the equipment may be hot to touch!

Please wait one-half hour after switching off before handling parts.

Battery Warning

Caution!



- Batteries are at risk of exploding if incorrectly installed
- Do not attempt to recharge, force open, or heat the battery
- Replace the battery only with the same or equivalent type recommended by the manufacturer

Service and Maintenance

- ONLY qualified personnel should service the system
- Shutdown the system, disconnect the power cord and all other connections before servicing the system
- When replacing/ installing additional components (expansion card, memory module, etc.), insert them as gently as possible while assuring proper connector engagement

ESD Precautions

- Handle add-on module, motherboard by their retention screws or the module's frame/ heat sink. Avoid touching the PCB circuit board or add-on module connector pins
- Use a grounded wrist strap and an anti-static work pad to discharge static electricity when installing or maintaining the system
- Avoid dust, debris, carpets, plastic, vinyl and Styrofoam in your work area
- Do not remove any module or component from its anti-static bag before installation

Restricted Access Location

The controller is intended for installation only in certain environments where both of the following conditions apply:

- Access can only be gained by QUALIFIED SERVICE PERSONNEL who have been instructed on the reasons for restrictions applied to the location and any precautions that shall be taken
- Access is through the use of a TOOL, lock and key, or other means of security, and is controlled by the authority responsible for the location

About This Manual

This guide introduces Neosys Nuvo-7501 series system. It is a compact fanless embedded controller with Intel® 9th/8th Gen Core™ i7/ i5/ i3 processor.

The guide also demonstrates the system's basic installation procedures.

Revision History

Version	Date	Description
1.0	Jul. 2020	Initial release
1.1	Jan. 2023	Updated Nuvo-7505D isolated COM port pin definition

1 Introduction

Nuvo-7501 series is a cost-effective, compact and yet powerful fanless embedded computer with a 255 x 173 x 76 mm footprint. Powered by an Intel® 9th/ 8th-Gen Core™ hexa/ octa core CPU, it offers more than 50% computation performance improvement over the previous generation.



Nuvo-7501 is designed to be simple and compact while retaining essential elements of a rugged embedded fanless solution. It features I/Os such as 2x GbE, 4x USB3.0 and 4x COM ports for common industrial applications. It features an M.2 2280 slot (SATA signal) and can also support a 2.5" SSD/ HDD or a 3.5" HDD. It's derivative model, Nuvo-7505D, offers isolated DIO and isolated COM (ports 1~4), which can protect the controller against ground loops in harsh environments.

The Nuvo-7501 is a cost-effective solution that has retained the quality of materials all Neosys systems utilize; and the design flow/ stringent test procedures it must endure. In other words, Nuvo-7501 does not compromise on quality and reliability! It is a fanless embedded platform that has hit the sweet spot in terms of cost, size and performance. Nuvo-7501 is an ideal fanless embedded solution for various industrial applications.

1.1 Product Specifications

1.1.1 Nuvo-7501 Specifications

System Core	
Processor	Supporting Intel® 8th/ 9th-Gen Core™ CPU (LGA1151 socket) - Intel® Core™ i7-8700*/ i7-8700T/ i7-9700E*/ i7-9700TE - Intel® Core™ i5-8500*/ i5-8500T/ i5-9500E*/ i5-9500TE - Intel® Core™ i3-8100*/ i3-8100T/ i3-9100E*/ i3-9100TE
Chipset	Intel® H310 platform controller hub
Graphics	Integrated Intel® UHD graphics 630
Memory	Up to 32 GB DDR4 2666/ 2400 SDRAM (one SODIMM slot)
I/O Interface	
Ethernet port	2x Gigabit Ethernet ports by I219 and I210
USB	4x USB3.1 Gen1 (5Gbps) ports
Video Port	1x VGA connector, supporting 1920 x 1200 resolution 1x DVI-D connector, supporting 1920 x 1200 resolution
Serial Port	2x software-programmable RS-232/ 422/ 485 ports (COM1/ COM2) 2x RS-232 ports (COM3/ COM4)
Audio	1x 3.5 mm jack for mic-in and speaker-out
Storage Interface	
SATA HDD	1x internal SATA port for 3.5" HDD or 2.5" HDD/ SSD
M.2	1x M.2 2280 SATA interface
Expansion Bus/ Internal I/O Interface	
mini-PCIe	1x full-size mini PCI Express socket
M.2	1x M.2 2242 B key socket with internal SIM socket
Power Supply	
DC Input	1x 3-pin pluggable terminal block for 8~35 VDC power input
Remote Ctrl & Status Output	1x 10-pin (2x5) pin header for remote on/off control and status LED output
Power Consumption	With i7-8700T (in 35W mode): 60W (Max.) @ 24V
Mechanical	
Dimension	255 mm (W) x 173 mm (D) x 76 mm (H)
Weight	2.68 kg (incl. CPU, memory and HDD)
Mounting	Wall-mount or optional DIN-rail
Environmental	

Storage Temperature	-40°C ~ 85°C
Operating Temperature	-25°C ~ 60°C ^{*/**/**}
Humidity	10%~90% , non-condensing
Vibration	Operating, MIL-STD-810G, Method 514.6, Category 4
Shock	Operating, MIL-STD-810G, Method 516.6, Procedure I, Table 516.6-II
EMC	CE/FCC Class A, according to EN 55032 & EN 55024

** Due to thermal limitations, 65W CPUs will be configured to operate in 35W mode by default.*

*** For sub-zero operating temperature, a wide temperature HDD or Solid State Disk (SSD) is required.*

**** For i7 CPUs, thermal throttling may occur when sustained full-loading applied at 60°C ambient temperature.*

1.1.2 Nuvo-7505D Specifications

System Core	
Processor	Supporting Intel® 8th/ 9th-Gen Core™ CPU (LGA1151 socket) - Intel® Core™ i7-8700*/ i7-8700T/ i7-9700E*/ i7-9700TE - Intel® Core™ i5-8500*/ i5-8500T/ i5-9500E*/ i5-9500TE - Intel® Core™ i3-8100*/ i3-8100T/ i3-9100E*/ i3-9100TE
Chipset	Intel® H310 platform controller hub
Graphics	Integrated Intel® UHD graphics 630
Memory	Up to 32 GB DDR4 2666/ 2400 SDRAM (one SODIMM slot)
I/O Interface	
Ethernet port	2x Gigabit Ethernet ports by I219 and I210
USB	4x USB3.1 Gen1 (5Gbps) ports
Video Port	1x VGA connector, supporting 1920 x 1200 resolution 1x DVI-D connector, supporting 1920 x 1200 resolution
Serial Port	2x software-programmable isolated RS-232/ 422/ 485 ports (COM1/ COM2) 2x isolated RS-232 ports (COM3/ COM4) 2x RS-232 ports (COM5/ COM6)
Audio	1x 3.5 mm jack for mic-in and speaker-out
Isolated DIO	8-CH isolated DI and 8-CH isolated DO
Storage Interface	
SATA HDD	1x internal SATA port for 3.5" HDD or 2.5" HDD/ SSD
M.2	1x M.2 2280 SATA interface
Expansion Bus/ Internal I/O Interface	
mini-PCle	1x full-size mini PCI Express socket
M.2	1x M.2 2242 B key socket with internal SIM socket
Power Supply	
DC Input	1x 3-pin pluggable terminal block for 8~35 VDC power input
Remote Ctrl & Status Output	1x 10-pin (2x5) pin header for remote on/off control and status LED output
Power Consumption	With i7-8700T (in 35W mode): 60W (Max.) @ 24V
Mechanical	
Dimension	255 mm (W) x 173 mm (D) x 76 mm (H)
Weight	2.68 kg (incl. CPU, memory and HDD)
Mounting	Wall-mount or optional DIN-rail
Environmental	

Storage Temperature	-40°C ~ 85°C
Operating Temperature	-25°C ~ 60°C ^{*/**/**}
Humidity	10%~90% , non-condensing
Vibration	Operating, MIL-STD-810G, Method 514.6, Category 4
Shock	Operating, MIL-STD-810G, Method 516.6, Procedure I, Table 516.6-II
EMC	CE/FCC Class A, according to EN 55032 & EN 55024

** Due to thermal limitations, 65W CPUs will be configured to operate in 35W mode by default.*

*** For sub-zero operating temperature, a wide temperature HDD or Solid State Disk (SSD) is required.*

**** For i7 CPUs, thermal throttling may occur when sustained full-loading applied at 60°C ambient temperature.*

1.2 Dimension



NOTE

All measurements are in millimeters (mm).

1.2.1 Top View of Nuvo-7501 Series

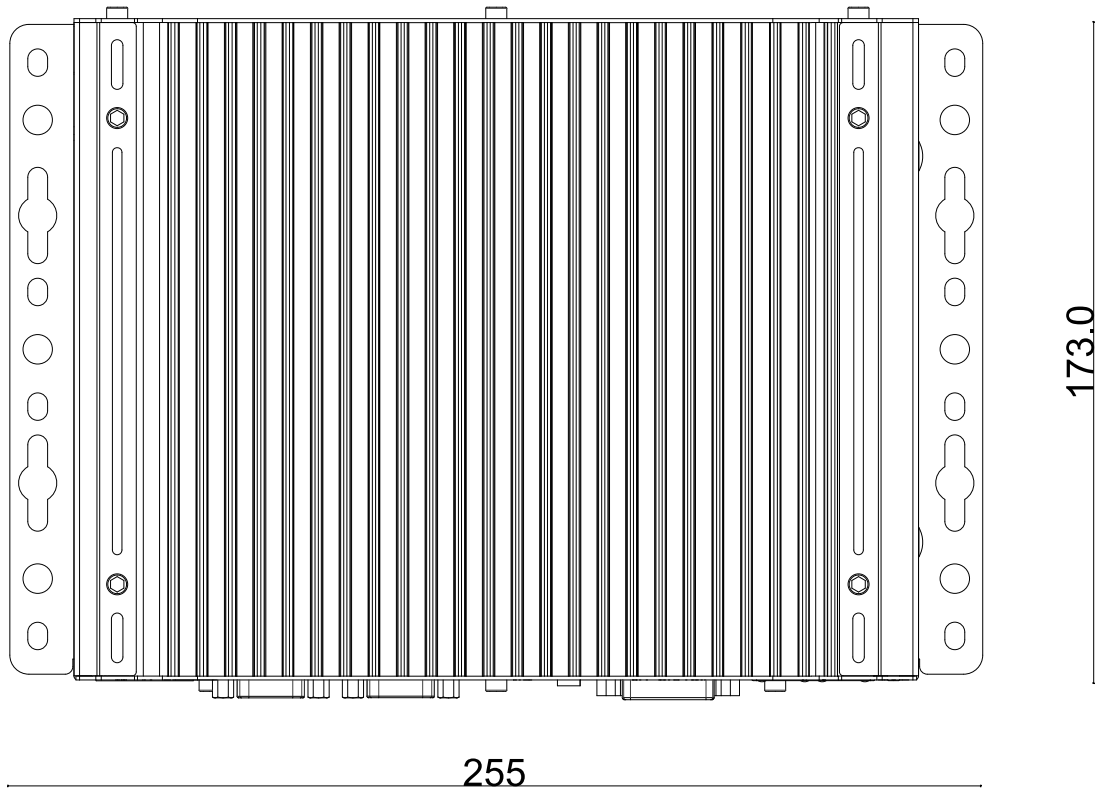

1.2.2 Front View of Nuvo-7501 Series

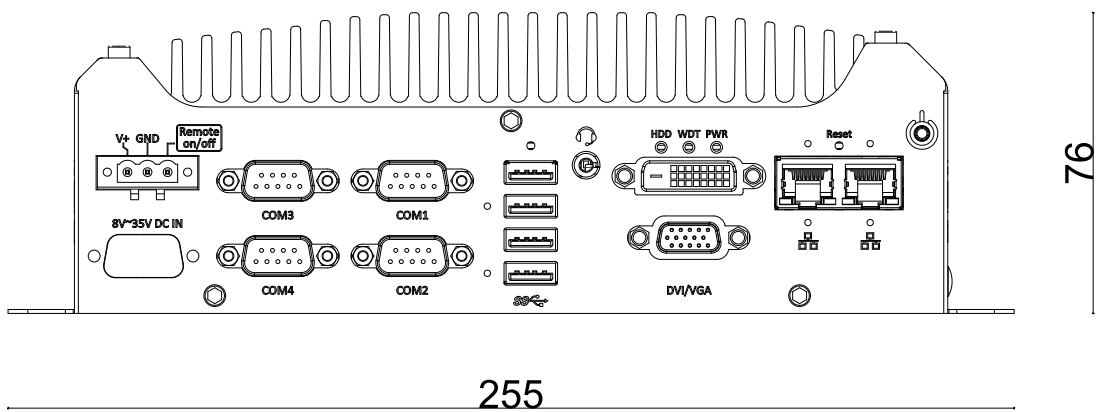

1.2.3 Back View of Nuvo-7501 Series

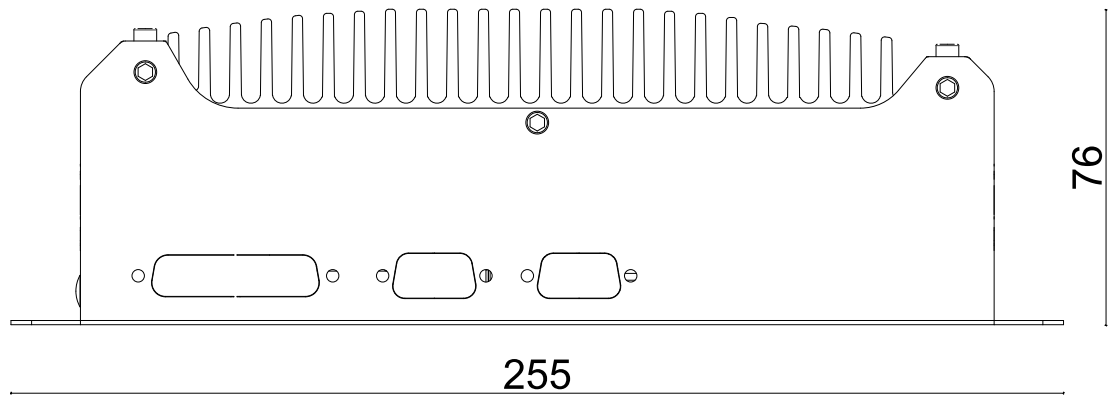

1.2.4 Side View of Nuvo-7501 Series

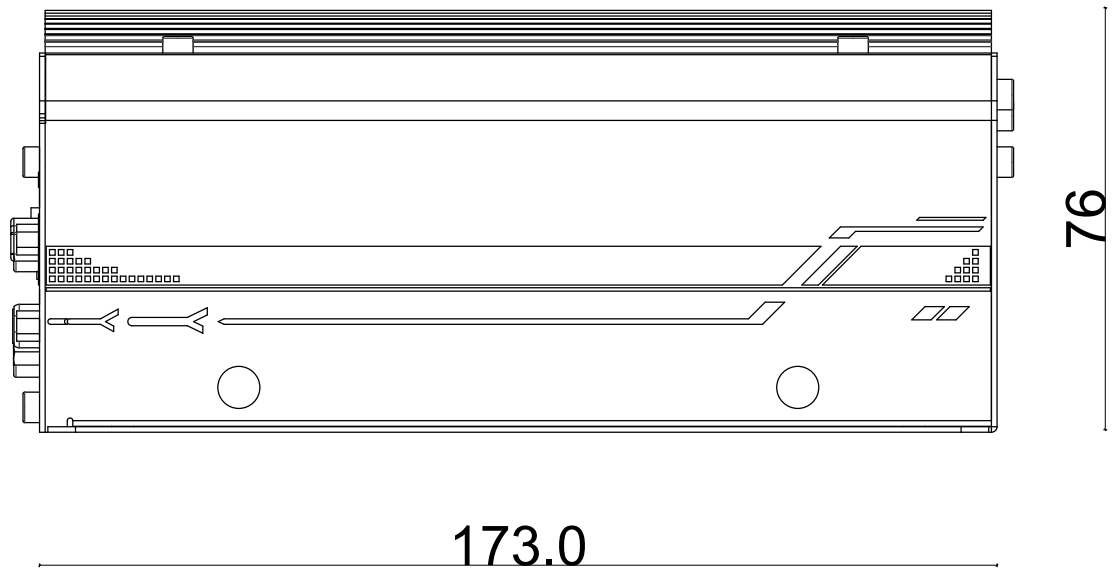

2 System Overview

Upon receiving and unpacking your Nuvo-7501/ 7505D, please check immediately if the package contains all the items listed in the following table. If any item(s) are missing or damaged, please contact your local dealer or Neosys Technology.

2.1 Nuvo-7501/ 7505D Series Packing List

System Pack	Nuvo-7501/ 7505D	Qty
1	Nuvo-7501/ 7505D (If you ordered CPU/ RAM/ HDD, please verify these items)	1
2	Accessory box, which contains <ul style="list-style-type: none"> ● HDD/SSD bracket ● CPU bracket ● Neosys drivers & utilities DVD ● 3-pin power terminal block ● Screw pack ● Rubber stands 	1 1 1 1 6 4

2.2 Front Panel I/O

The Nuvo-7501 I/O panel features two gigabit Ethernet ports, four USB3.1 Gen1 ports, one VGA connector, one DVI-D connector and four serial ports.

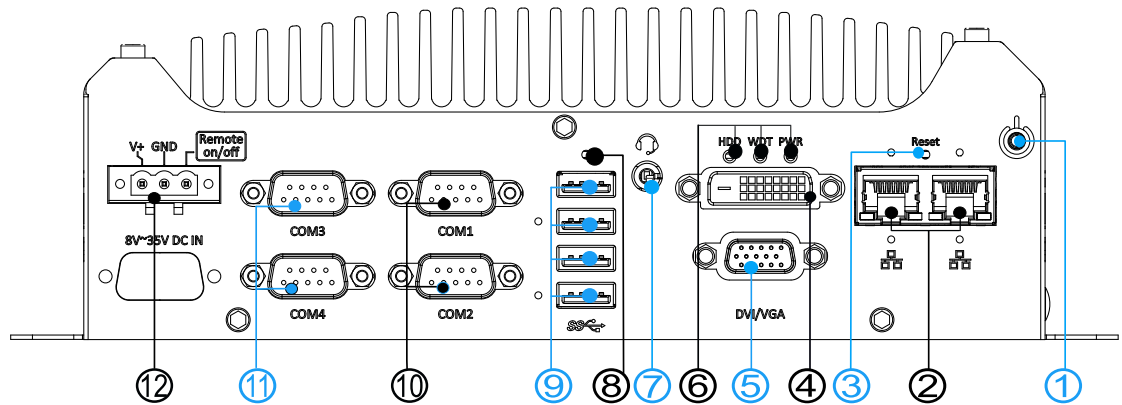

No.	Item	Description
1	Power button	Use this button to turn on or shutdown the system.
2	Ethernet port	The Ethernet ports support 10/ 100/ 1000Mbps network connections.
3	Reset button	Use this button to manually reset the system.
4	DVI-D port	DVI-D output supports resolution up to 1920x1200 and is compatible with other digital connections via an adapter.
5	VGA port	VGA output supports resolution up to 1920x1200.
6	System status LEDs	Three system LEDs, Power (PWR), Watchdog Timer (WDT), and Hard Disk Drive (HDD).
7	4-pole 3.5mm headphone/speaker jack	3.5mm jack for speaker-out or microphone-input.
8	CMOS reset	Use this button to manually reset the CMOS (BIOS).
9	USB 3.1 Gen1 port	USB 3.1 Gen1 port supports up to 5 Gbit/s data transfer bandwidth.
10	COM port 1 & 2	COM ports 1 & 2 are software-configurable RS-232/422/485 ports. The ports are isolated on Nuvo-7505D system.
11	COM port 3 & 4	COM3 and COM4 are standard 9-wire RS-232 ports. The ports are isolated on Nuvo-7505D system.
12	3-pin terminal block (DC/remote on/ off)	Compatible with DC power input from 8~35V, the terminal block is also used for remote on/ off control.

2.2.1 Power Button

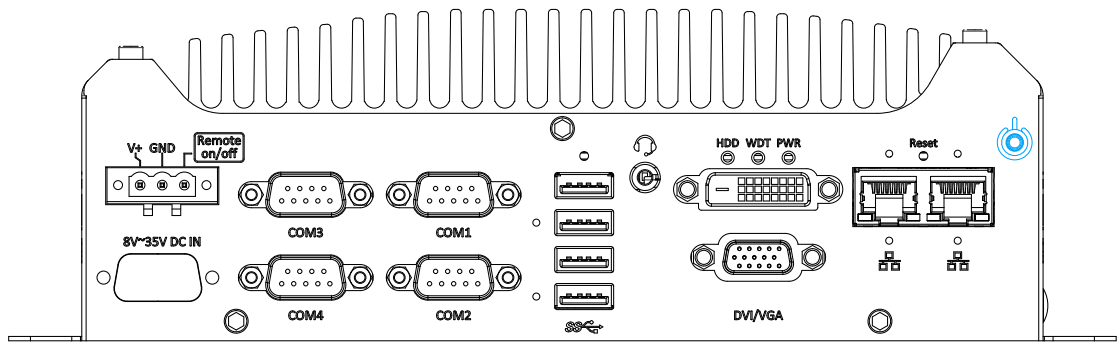

The power button is a non-latched switch for ATX mode on/off operation. Press to turn on the system, PWR LED should light up and to turn off, you can either issue a shutdown command in the OS, or just press the power button. In case of system halts, you can press and hold the power button for 5 seconds to force-shutdown the system. Please note that there is a 5 seconds interval between two on/off operations (i.e. once turning off the system, you will need to wait for 5 seconds to initiate another power-on operation).

2.2.2 Ethernet Port

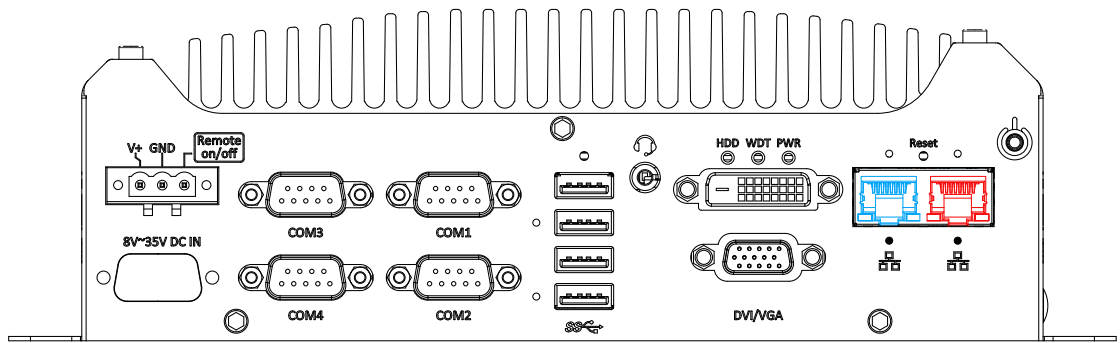

The system offers two GbE ports on its I/O panel. The GbE ports are marked in **blue/red** and are implemented with Intel® I219-LM/ Intel® I210-IT controllers, respectively. Each port has one dedicated PCI Express link for maximum performance. When an Ethernet connection is established, the LED indicators on the RJ45 connector represents the following connection statuses:

Active/Link LED

LED Color	Status	Description
Green	Off	Ethernet port is disconnected
	On	Ethernet port is connected and no data transmission
	Flashing	Ethernet port is connected and data is transmitting/receiving

Speed LED

LED Color	Status	Description
Green or Orange	Off	10 Mbps
	Green	100 Mbps
	Orange	1000 Mbps

The port implemented using Intel® I219-LM (in blue) supports Wake-on-LAN function. Drivers may be required to utilize the GbE port in Windows environment.

2.2.3 Reset Button

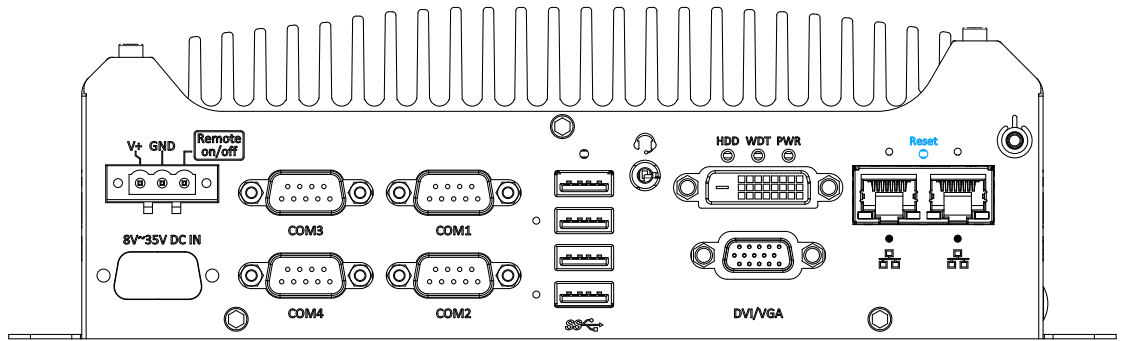

The reset button can be used to manually reset the system in case of abnormal condition. To avoid unexpected operation, the reset button is hidden behind the front panel. You need to use a pin-like object to push the reset button.

2.2.4 DVI Port

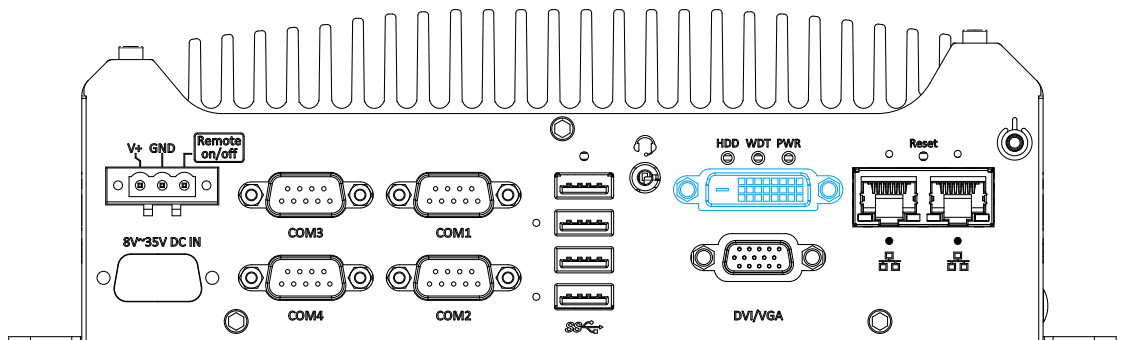

The system has one DVI-D connector on its I/O panel to support independent display output. DVI transmits graphics data in digital format and therefore can deliver better image quality at high resolutions. The DVI connector can output DVI or other digital signals via an adapter or dedicated cable up to 1920 x 1200 resolution.



DVI to HDMI cable



DVI-VGA adapter

2.2.5 VGA Port

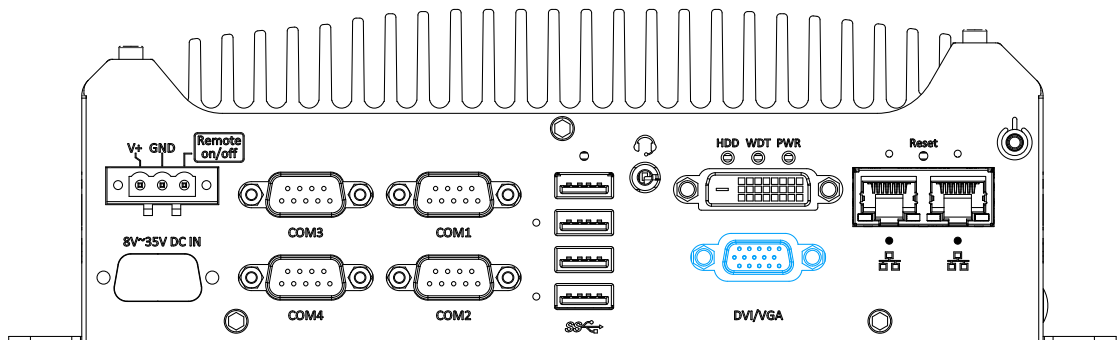

Nuvo-7501 series has dual display outputs on its front panel for connecting different displays according to your system configuration. VGA connector is the most popular way for connecting a display. The VGA output on Nuvo-7501 series supports up to 1920 x 1200 resolution. To support multiple display outputs and achieve best DVI output resolution in Windows, you need to install corresponding graphics driver. Please refer to section 5.5 for information on driver installation.



NOTE

Please make sure your VGA cable includes SDA and SCL (DDC clock and data) signals for correct communication with monitor to get resolution/timing information. A cable without SDA/SCL can cause blank screen on your VGA monitor due to incorrect resolution/timing output.

2.2.6 System Status LED

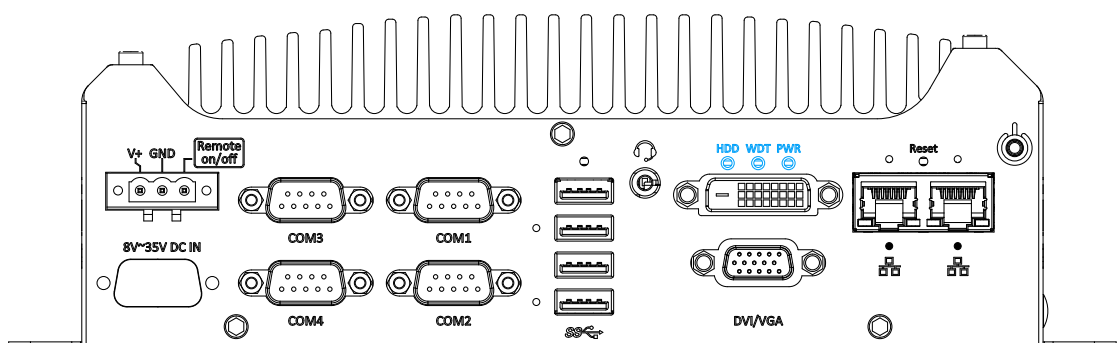

There are three LED indicators on the I/O panel: PWR, WDT and HDD. The descriptions of these three LED are listed in the following table.

Indicator	Color	Description
PWR	Green	Power indicator, lighted-up when system is on.
WDT	Yellow	Watchdog timer LED, flashing when watchdog timer is started.
HDD	Red	Hard drive indicator, flashing when SATA HDD is active.

2.2.7 4-Pole 3.5mm Microphone-in/ Speaker-out Jack

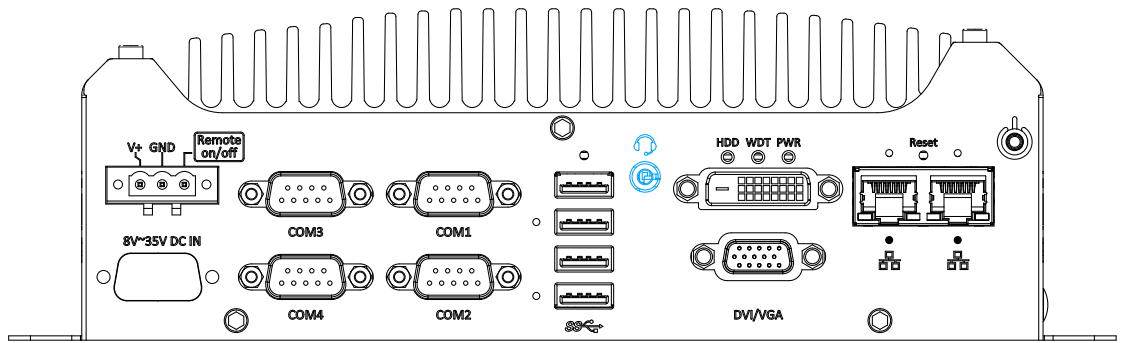

There is a female 4-pole  audio jack for headphone (speaker) output and microphone input. To utilize the audio function in Windows, you need to install corresponding drivers. Please refer to the section, [Driver Installation](#).

2.2.8 CMOS Reset Button

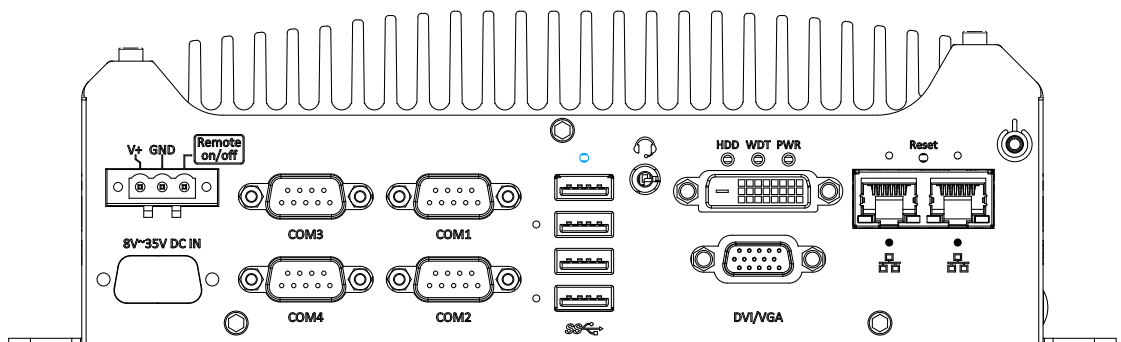

The CMOS Reset button is used to manually reset the motherboard BIOS in case of system halt or malfunction. To avoid unexpected operation, it is purposely placed behind the panel. To reset, please use the tip of a pen, press and hold for at least 5 seconds to reset the BIOS.

2.2.9 USB 3.1 Gen1 Port

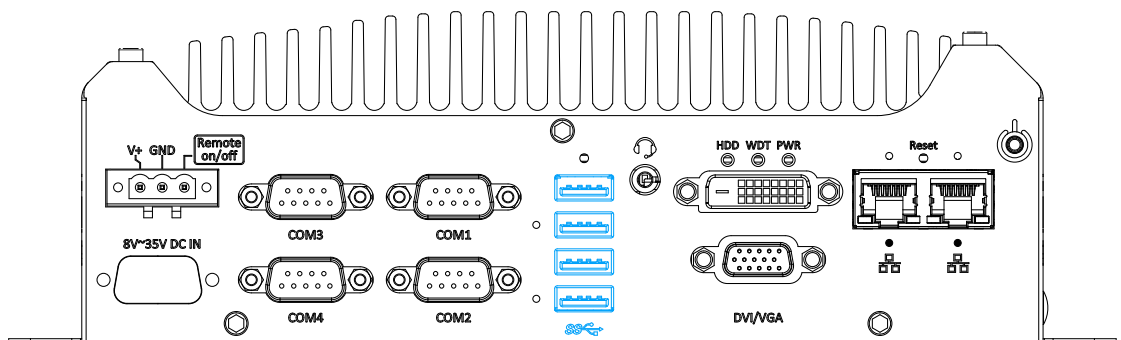

The system offers four USB 3.1 Gen1 (SuperSpeed USB) ports on its front panel. They are backward compatible with USB 2.0, USB 1.1 and USB 1.0 devices. Legacy USB support is also provided so you can use USB keyboard/mouse in DOS environment while USB 3.1 Gen1 driver is supported natively in Windows 10.

2.2.10 Nuvo-7501 COM Port

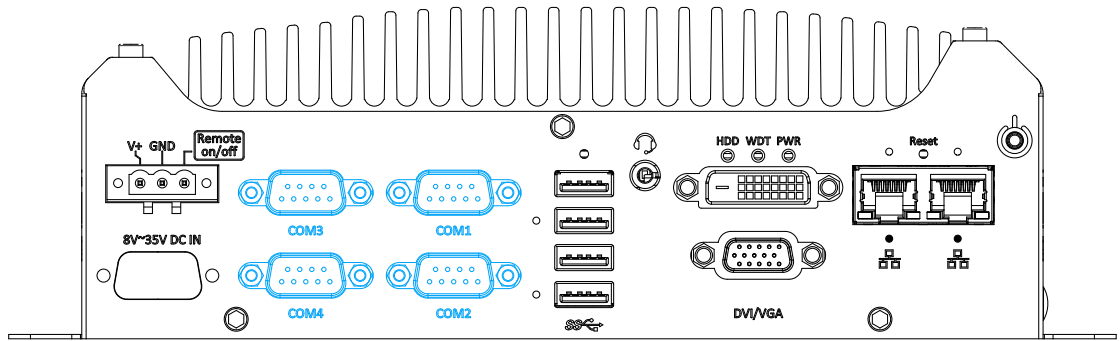

The system provides four COM ports for communicating with external devices. These COM ports are implemented using industrial-grade ITE8786 Super IO chip (-40 to 85°C) and provide up to 115200 bps baud rate.

COM1 and COM2 are software-configurable RS-232/422/485 ports. COM3 and COM4 are standard 9-wire RS-232 ports. The operation mode of COM1 and COM2 can be set in BIOS setup utility. The following table describes the pin definition of COM ports.

COM Port Pin Definition

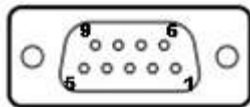

Pin#	COM1 & COM2			COM3 & COM4
	RS-232 Mode	RS-422 Mode	RS-485 Mode (Two-wire 485)	RS-232 Mode
1	DCD			DCD
2	RX	422 TXD+	485 TXD+/RXD+	RX
3	TX	422 RXD+		TX
4	DTR	422 RXD-		DTR
5	GND	GND	GND	GND
6	DSR			DSR
7	RTS			RTS
8	CTS	422 TXD-	485 TXD-/RXD-	CTS
9	RI			RI

2.2.11 Nuvo-7505D Isolated COM Port

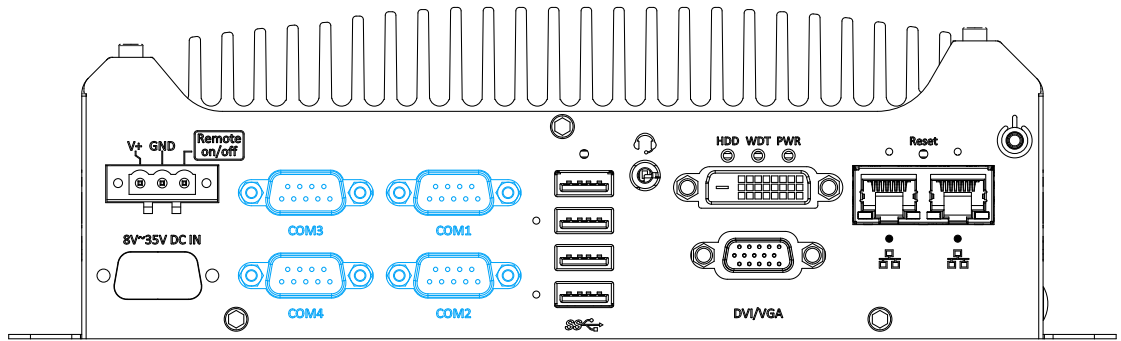

The system provides four isolated COM ports that can shield the controller from ground loops while communicating with external devices. These COM ports are implemented using industrial-grade ITE8786 Super IO chip (-40 to 85°C) and provide up to 115200 bps baud rate.

COM1 and COM2 are software-configurable RS-232/422/485 ports. COM3 and COM4 are 3-wire RS-232 ports. The operation mode of COM1 and COM2 can be set in BIOS setup utility. The following table describes the pin definition of COM ports.

COM Port Pin Definition

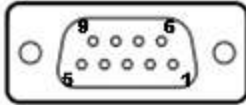

Pin#	COM1 & COM2			COM3 & COM4
	RS-232 Mode	RS-422 Mode	RS-485 Mode (Two-wire 485)	RS-232 Mode
1				
2	RX	422 TXD+	485 TXD+/RXD+	RX
3	TX	422 RXD+		TX
4		422 RXD-		
5	ISOGND	ISOGND	ISOGND	ISOGND
6				
7				
8		422 TXD-	485 TXD-/RXD-	
9				

2.2.12 3-Pin Terminal Block for DC Input

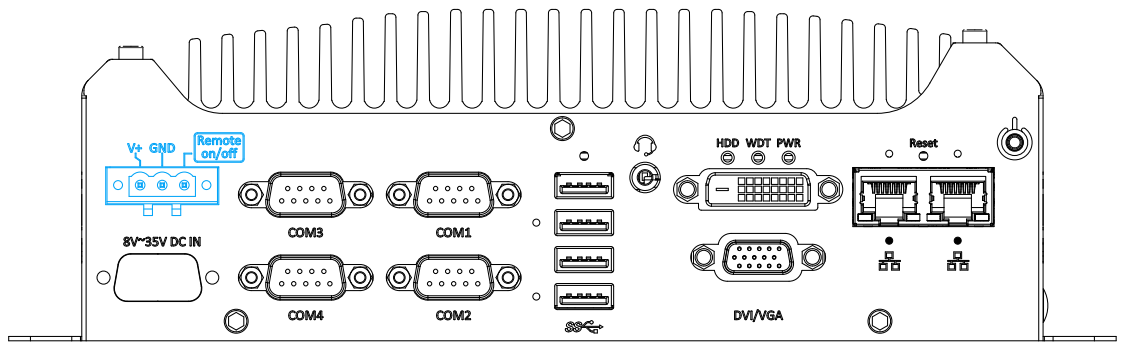

The system allows DC power input from 8 to 35V via a 3-pin pluggable terminal block, which is ideal for field usage where DC power is provided. The screw clamping mechanism of the terminal block offers utmost reliability when wiring DC power.

Symbol	Description
Remote on/off	Connecting to an external switch to turn on/off the system.
GND	Negative polarity (ground) of DC input
V+	Positive polarity of DC input

2.3 Rear Panel DIO Port (Nuvo-7505D Only)

The digital input (DI) and digital output (DO) function provides eight isolated DI and eight isolated DO on the back panel of the system via DB25 female connector.

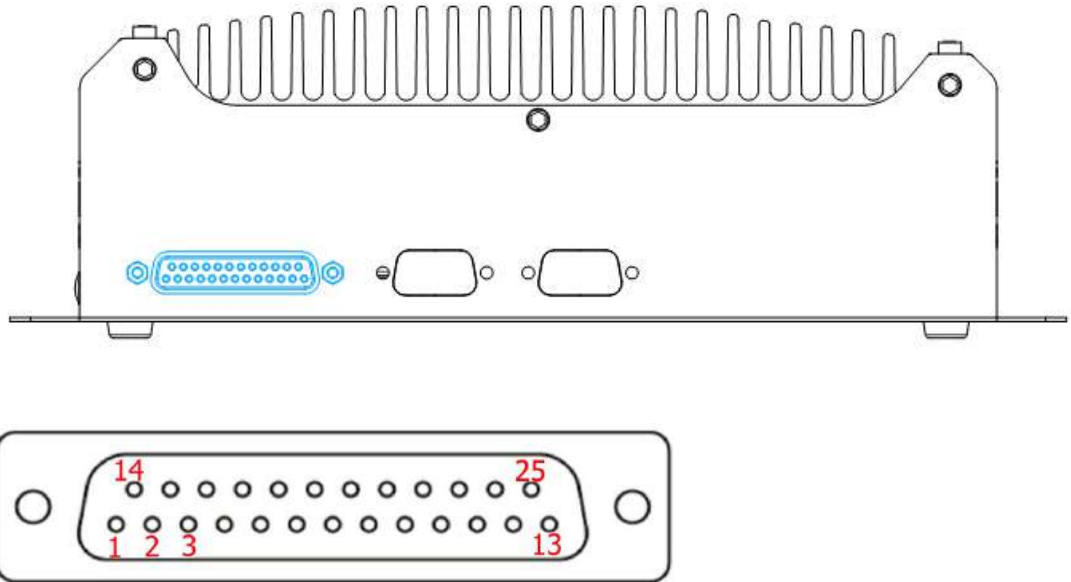

Pin Definition

Pin #	Signal	Pin #	Signal
1	VDD	14	DOGND
2	DO0*	15	DO1 *
3	DO2 *	16	DO3 *
4	DO4	17	DO4GND
5	DO5	18	DO5GND
6	DO6	19	DO6GND
7	DO7	20	DO7GND
8	DIGND	21	D10
9	D14	22	D11
10	D15	23	DIGND
11	DIGND	24	D12
12	D16	25	D13
13	D17		

* When using DO0 ~ DO3, DOGND is the ground should be used.

2.4 Rear Panel COM Ports (Nuvo-7505D Only)

There are two additional RS-232 COM ports on the back panel of the system via standard 9-wire connectors.

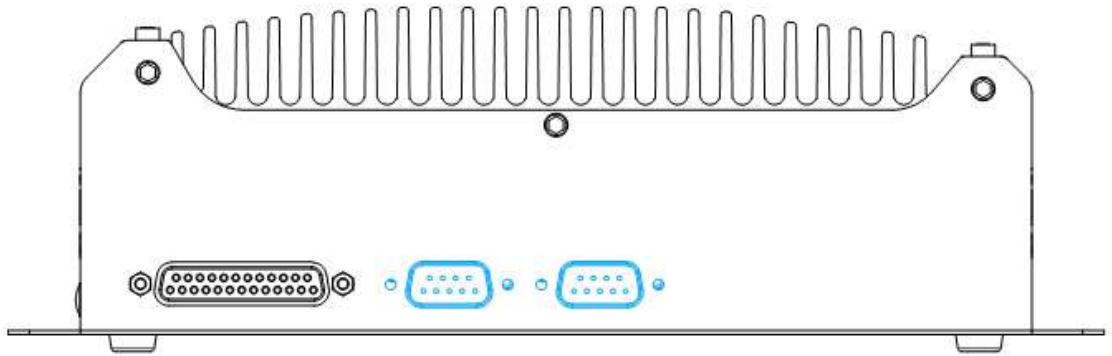

COM Port Pin Definition

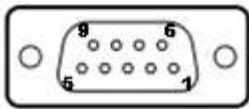

COM5 & COM6	
Pin#	RS-232 Mode
1	DCD
2	RX
3	TX
4	DTR
5	GND
6	DSR
7	RTS
8	CTS
9	RI

2.5 Internal I/O Functions

In addition to I/O connectors on the front panel, the system also provides internal on-board connectors, such as remote on/off control, LED status output, internal USB 2.0 ports and etc. In this section, we'll illustrate these internal I/O functions.

2.5.1 Status LED Output & Remote On/ Off Control

For an application which places the system inside a cabinet, it's useful to have an external system status LED indicators. The system provides a 2x6, 2.0mm pitch pin header to output system status such as power, HDD, watchdog timer, and control system on/ off remotely.

The status LED output has a built-in series-resistor and provides 10mA current to directly drive the external LED indicators. System on/ off control is also provided so you can use an external non-latched switch to turn on/ off the system exactly the same as the power button on the front panel. The following table describes the pin definition of the status LED output.

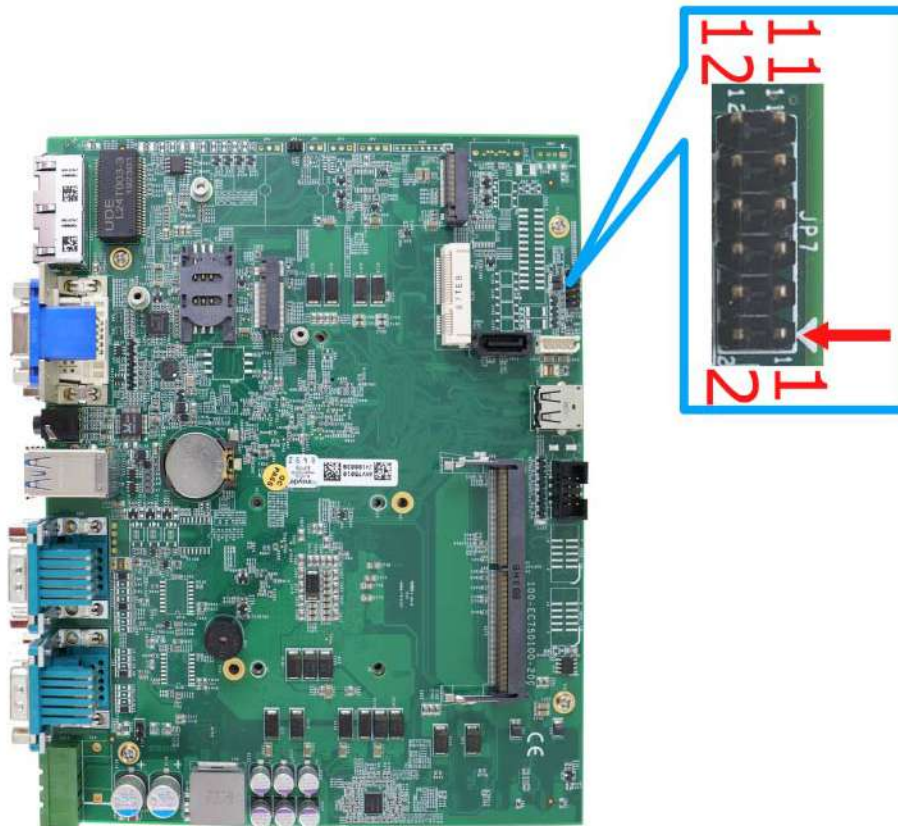

Location of status LED output & remote on/ off control

Pin Definition

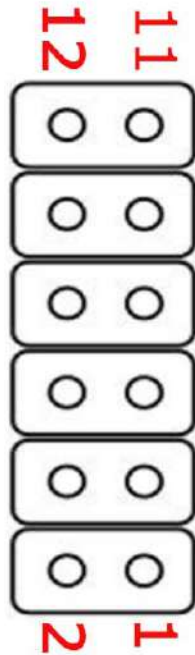

Pin#	Definition	Description
1	WDT_LED-	[Output] Watchdog timer indicator, flashing when watchdog timer is started.
2	WDT_LED+	
3	NA	Un-used pin
4	NA	
5	HDD-	[Output] Hard drive indicator, flashing when SATA hard drive is active.
6	HDD+	
7	Power_LED-	[Output] System power indicator, on if system is turned on, off if system is turned off.
8	Power_LED+	
9	Ctrl-	[Input] Remote on/off control, connecting to an external switch to turn on/off the system. (polarity is negligible).
10	Ctrl+	
11	NA	Un-used pin
12	NA	

 **NOTE**

Please make sure the polarity is correct when you connect the external LED indicator to the Status LED Output.

2.5.2 M.2 2280 (M Key) Slot for SSD (SATA Signal Only)

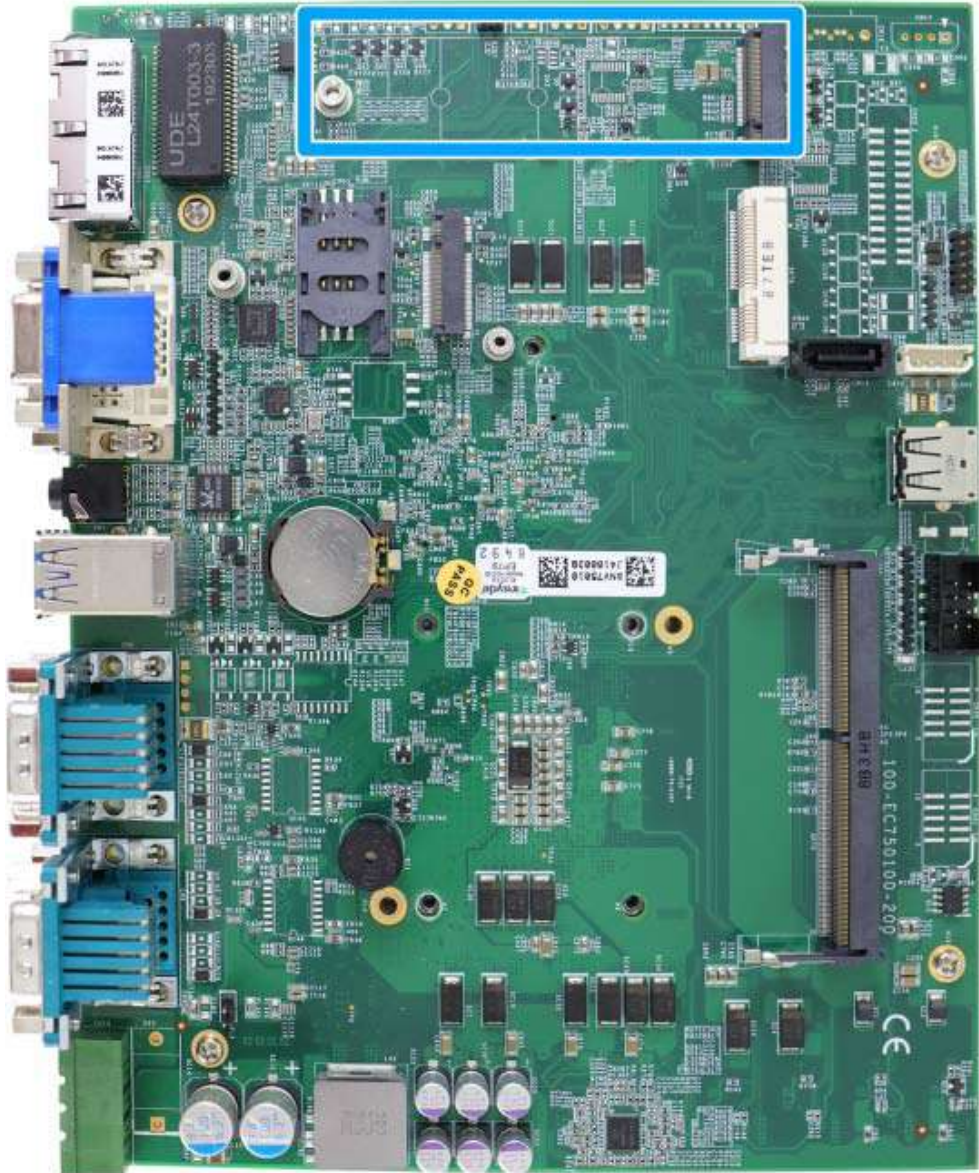

The system has an M.2 2280 slot (SATA signal only) for you to install an M.2 SATA SSD.



NOTE

The M.2 slot is only compatible with SATA signal M.2 SSD only.

M.2 2280 M Key Pin Definition

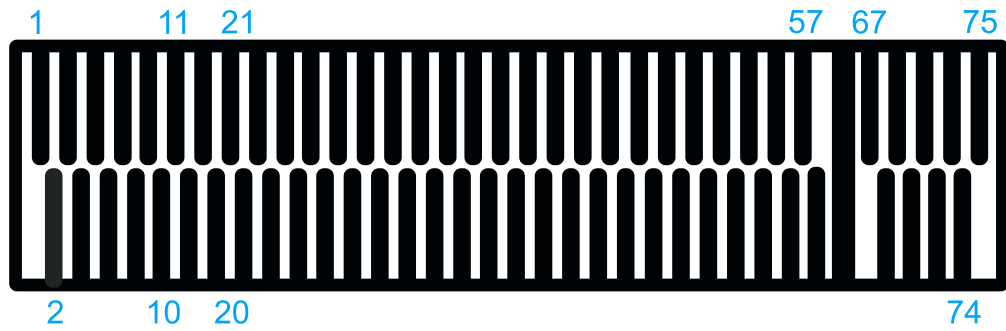

Pin #	Signal	Pin #	Signal
1		2	+3V3
3	GND	4	+3V3
5	GND	6	-
7		8	-
9	GND	10	DAS/DSS N
11		12	+3V3
13		14	+3V3
15	GND	16	+3V3
17		18	+3V3
19		20	-
21	GND	22	-
23		24	-
25		26	-
27	GND	28	-
29		30	-
31		32	-
33	GND	34	-
35		36	-
37		38	-
39	GND	40	-
41	SATA-B+	42	-
43	SATA-B-	44	-
45	GND	46	-
47	SATA-A-	48	-
49	SATA-A+	50	
51	GND	52	-
53		54	-
55		56	-
57	GND	58	-
Mechanical Key			
67	-	68	
69		70	+3V3
71	GND	72	+3V3
73	GND	74	+3V3
75	GND		

2.5.3 Single DRAM SO-DIMM Slot

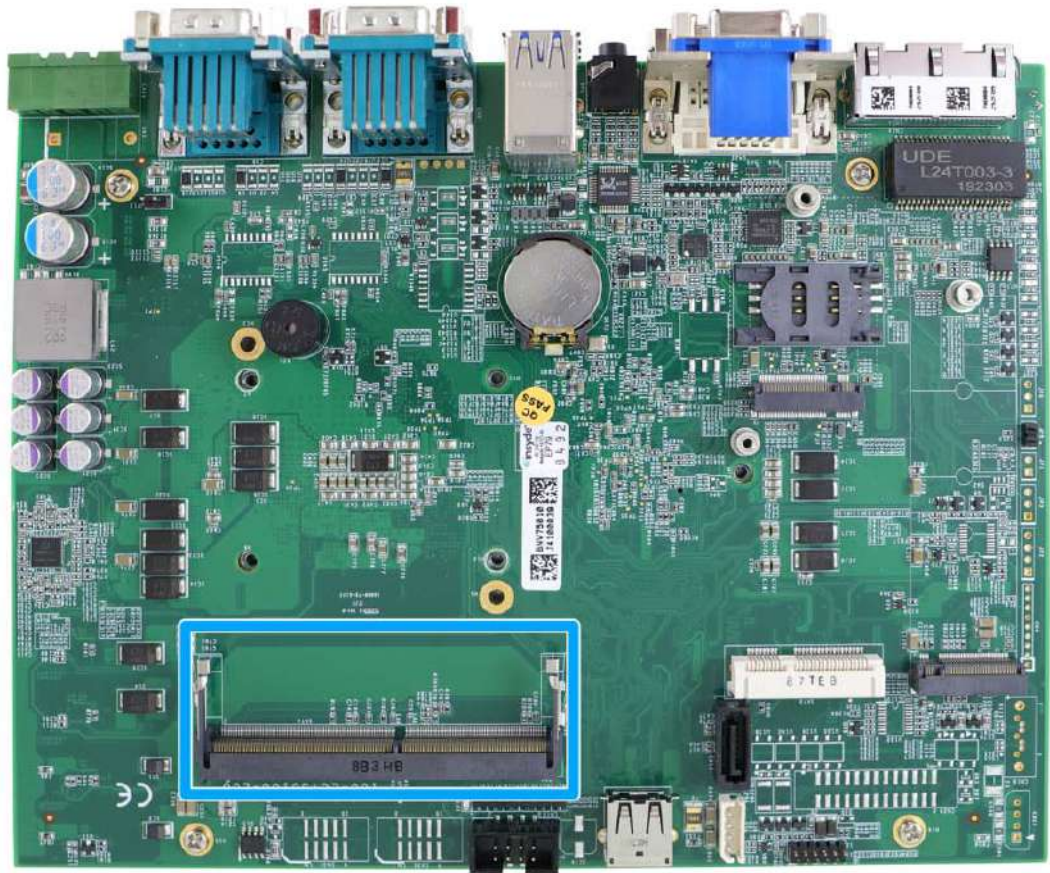

The system motherboard supports one 260-pin SODIMM socket for installing one DDR4-2666/ 2400 memory module up to 32GB capacity.

2.5.4 mini-PCIe Slot

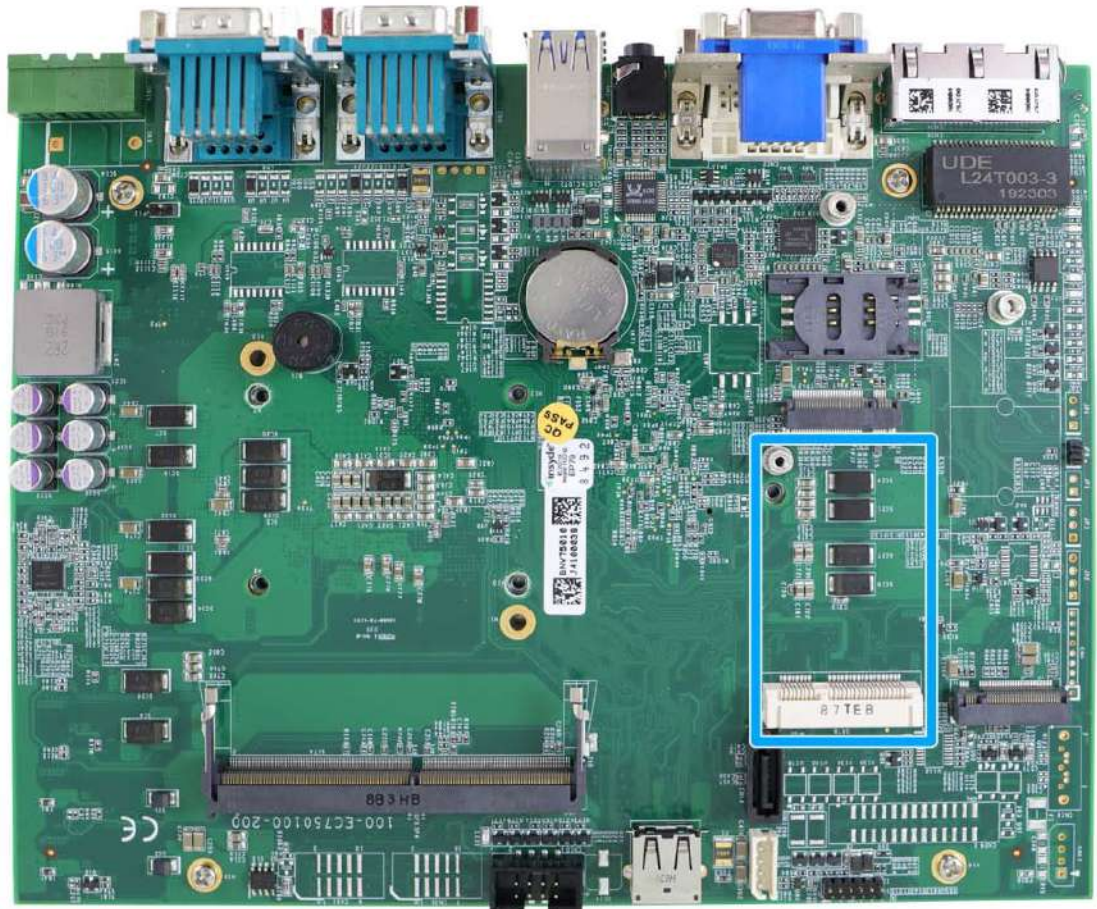

The system provides a mini-PCIe socket compliant with mini-PCIe specification rev. 1.2. There are plenty of off-the-shelf mini-PCIe modules with versatile capabilities. By installing a mini-PCIe module, your system can have expanded features such as WIFI, GPS, CAN bus, analog frame grabber, etc.

For SMA antenna installation, there are dedicated openings located on the side of the chassis.



mini-PCle slot definition

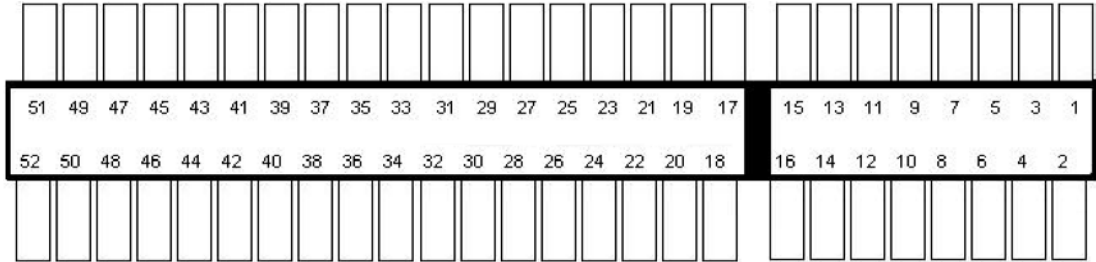

Pin #	Signal	Pin #	Signal
1	WAKE#	2	+3.3Vaux
3	COEX1	4	GND
5	COEX2	6	+1.5V
7	CLKREQ#	8	UIM PWR
9	GND	10	UIM DATA
11	REFCLK-	12	UIM CLK
13	REFCLK+	14	UIM RESET
15	GND	16	UIM VPP
Mechanical Key			
17	Reserved* (UIM C8)	18	GND
19	Reserved* (UIM C4)	20	W DISABLE#
21	GND	22	PERST#
23	PERn0	24	+3.3Vaux
25	PERp0	26	GND
27	GND	28	+1.5V
29	GND	30	SMB CLK
31	PETn0	32	SMB DATA
33	PETp0	34	GND
35	GND	36	USB D-
37	GND	38	USB D+
39	+3.3Vaux	40	GND
41	+3.3Vaux	42	LED WWAN#
43	GND	44	LED WLAN#
45	Reserved	46	LED WPAN#
47	Reserved	48	+1.5V
49	Reserved	50	GND
51	Reserved	52	+3.3Vaux

2.5.5 M.2 2242 B Key and SIM Card Slot

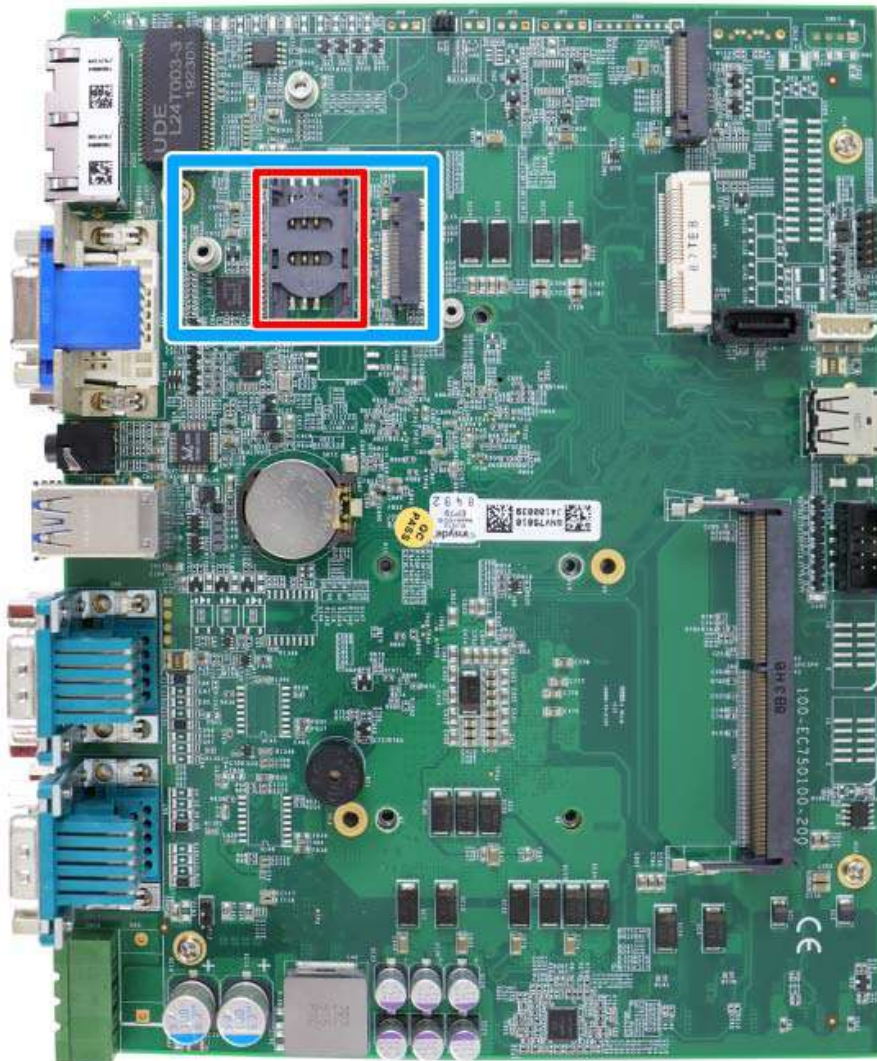

The system has a M.2 2242 (indicated in **blue**) slot that works in cooperation with a SIM slot (indicated in **red**). By installing a M.2 module, you can install a 3G/ 4G module with a SIM card for internet access via your service provider's 3G/ 4G network.

For SMA antenna installation, there are dedicated openings located on the side of the chassis.



M.2 Slot Pin Definition

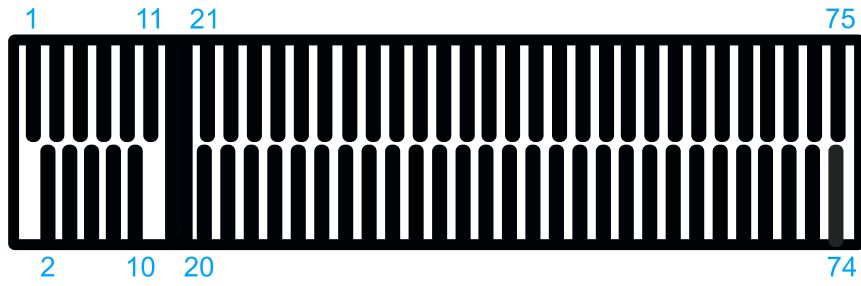

Pin #	Signal	Pin #	Signal
1	-	2	3V3
3	GND	4	3V3
5	GND	6	-
7	USB_D+	8	-
9	USB_D-	10	-
11	GND	12	KEY
13	KEY	14	
15		16	
17		18	
19		20	-
21	-	22	-
23	-	24	-
25	-	26	-
27	GND	28	-
29	-	30	UIM1-RESET
31	-	32	UIM1-CLK
33	GND	34	UIM1-DATA
35	-	36	UIM1-PWR
37	-	38	-
39	GND	40	-
41	PERn0	42	-
43	PERp0	44	-
45	GND	46	-
47	PETn0	48	-
49	PETp0	50	PERST_N
51	GND	52	-
53	REFCLKN	54	-
55	REFCLKP-	56	-
57	GND	58	-
59	-	60	-
61	-	62	-
63	-	64	-
65	-	66	IM1_DETECT
67	RESET_N	68	-
69	-	70	3V3
71	GND	72	3V3
73	GND	74	3V3
75	-		

2.5.6 SATA Port

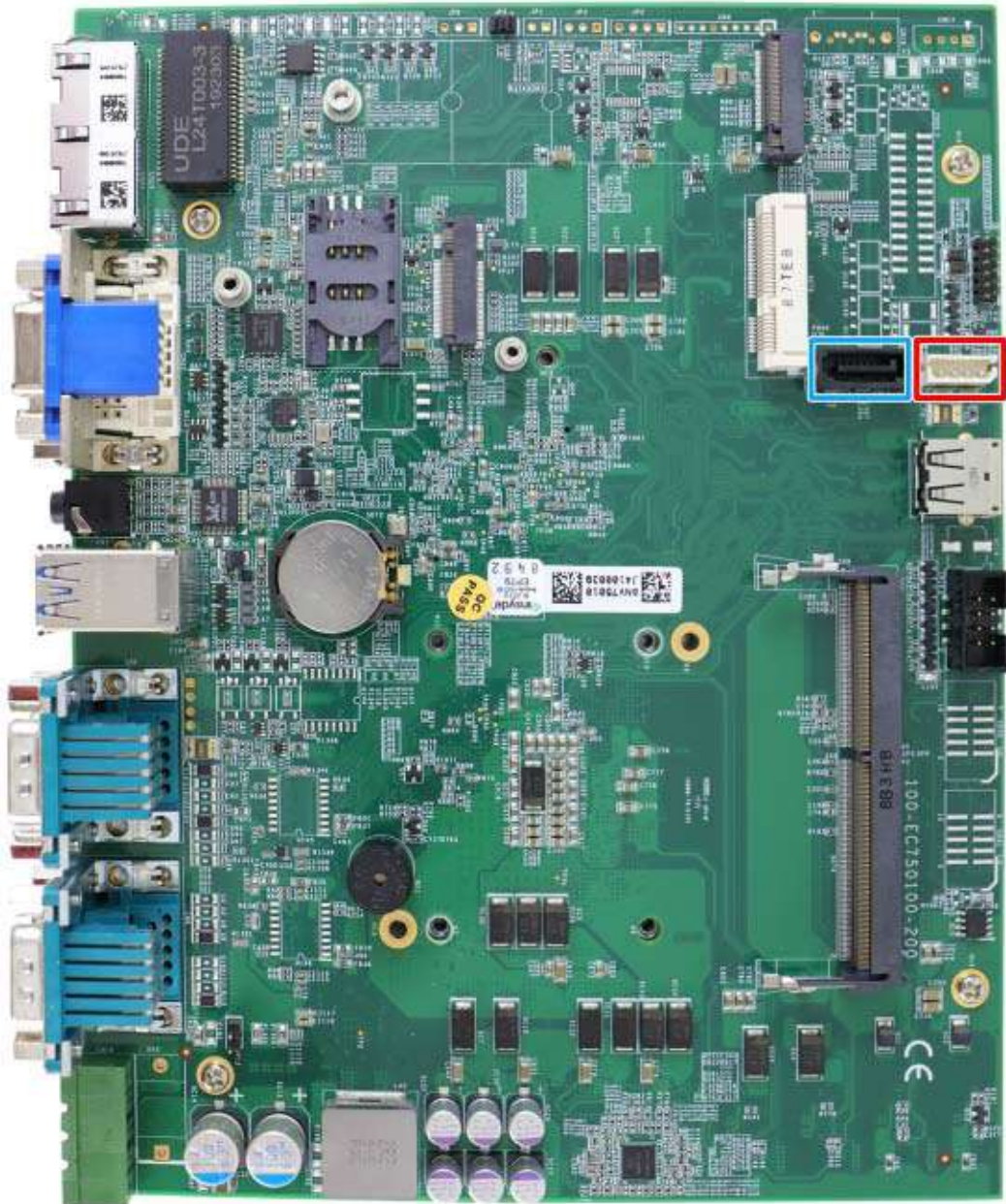

The system provides one SATA port which support Gen3, 6 Gb/s SATA signals. The SATA port is composed of a 7-pin SATA connector (indicated in blue) and a 4-pin power connector (indicated in red). A dedicated cable is shipped with the system to provide a standard 22-pin SATA connector to the installed device.

2.5.7 Internal USB Port

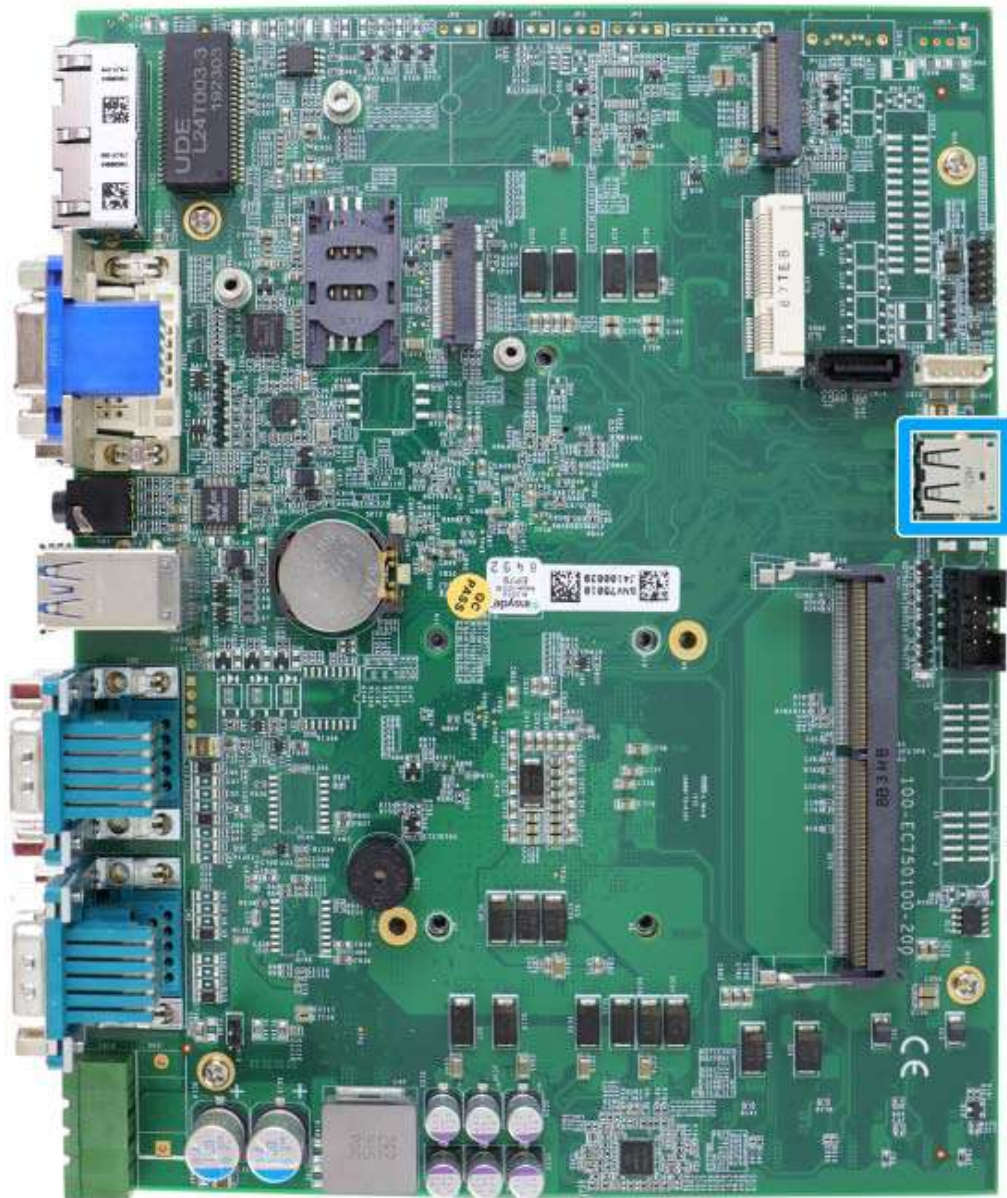

The system provides one additional USB port internally on the PCBA. It supports standard USB 2.0 signals. You can utilize this USB port to connect a USB protection dongle inside the chassis of the controller.



WARNING

DO NOT use a USB flash drive with a metallic enclosure that conducts electricity which may short-circuit the motherboard!

3 System Installation

Before disassembling the system enclosure and installing components and modules, please make sure you have done the following:

- It is recommended that only qualified service personnel should install and service this product to avoid injury or damage to the system.
- Please observe all ESD procedures at all times to avoid damaging the equipment.
- Before disassembling your system, please make sure the system has powered off, all cables and antennae (power, video, data, etc.) are disconnected.
- Place the system on a flat and sturdy surface (remove from mounts or out of server cabinets) before proceeding with the installation/ replacement procedure.

3.1 Disassembling the System

To access system internal components, the system needs to be disassembled. To disassemble the system enclosure, you need to remove screws on the I/O panel, removable and side panel.

1. On the I/O panel side, unscrew the three (3) screws shown below.



2. Unscrew the four (4) screws shown on top of the enclosure.



3. Unscrew the three (3) screws (indicated in blue) to remove the rear panel.



4. Unscrew the four (4) screws at the bottom of the system.



5. Gently lift and remove the bottom panel.
6. For Nuvo-7505D, you must disconnect the DIO and COM port connections to the motherboard before removing the enclosure.

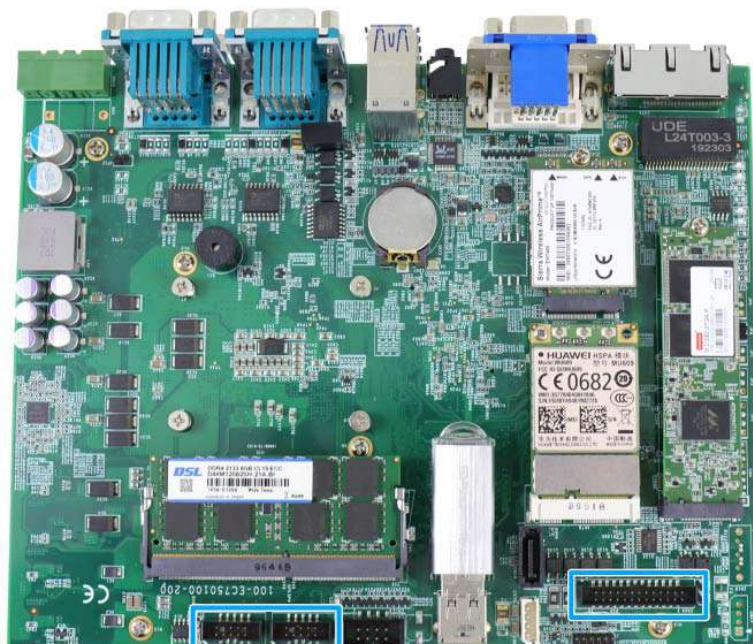

3.2 CPU Installation

1. **DO NOT** remove the CPU from its container / tray before it is ready to be installed.
2. With the enclosure panels removed, to access the CPU socket, please do the following:
 - i. If you are installing a CPU for the first time, remove the four (4) screws indicated in **blue**.
 - ii. If you see the five (5) screws indicated in **red**, the system may already have a CPU installed. To gain access to the CPU socket, you will also need to remove the five (5) screws indicated in **red**.

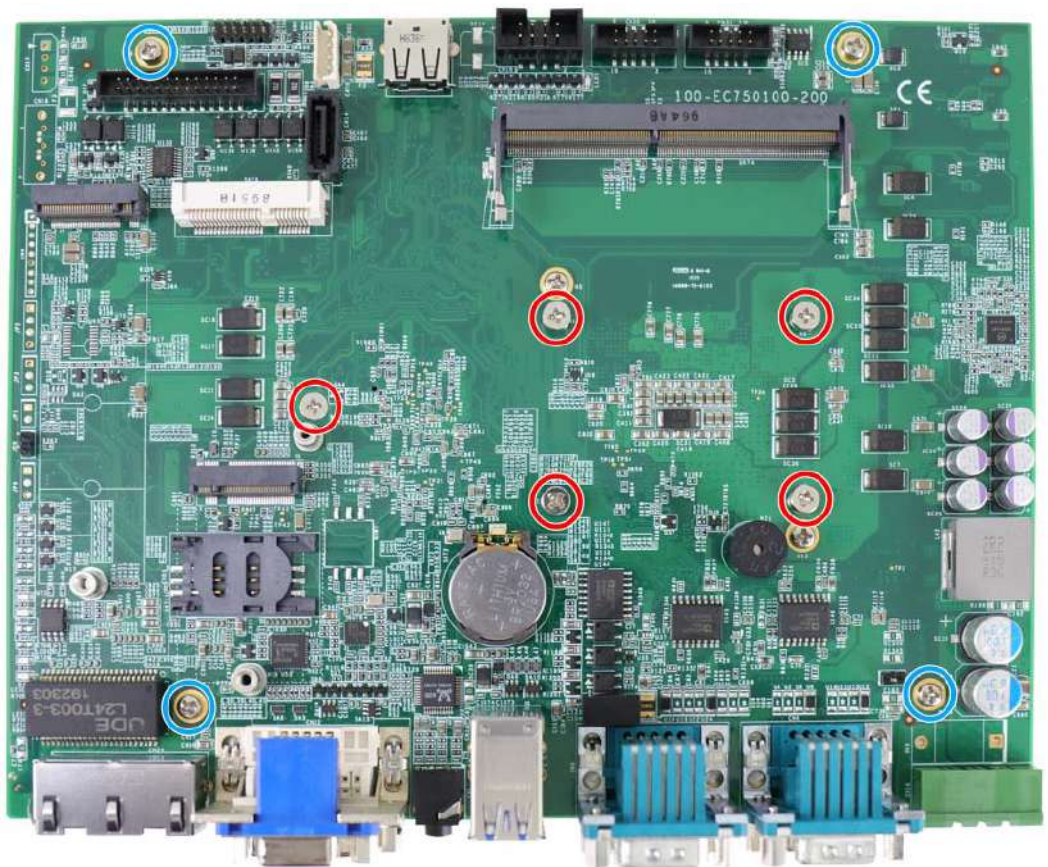

3. Between the motherboard and the heatsink, you'll see the CPU socket protective cover, place finger tips underneath the sign "REMOVE" for leverage and gently lift the cover.

 **WARNING**

With the protective cover removed, please be careful when handling the motherboard. DO NOT touch the pins in the LGA socket!

4. Remove the CPU from its container/ tray. Match the two notches on the side to the protrusions in the socket, gently lower the CPU into the socket.



5. Locate the CPU retention bracket from the accessory box. Place the retention bracket on the CPU and hold it in place.



6. Turn the motherboard around and secure the bracket by tightening two M3 P-head screws.

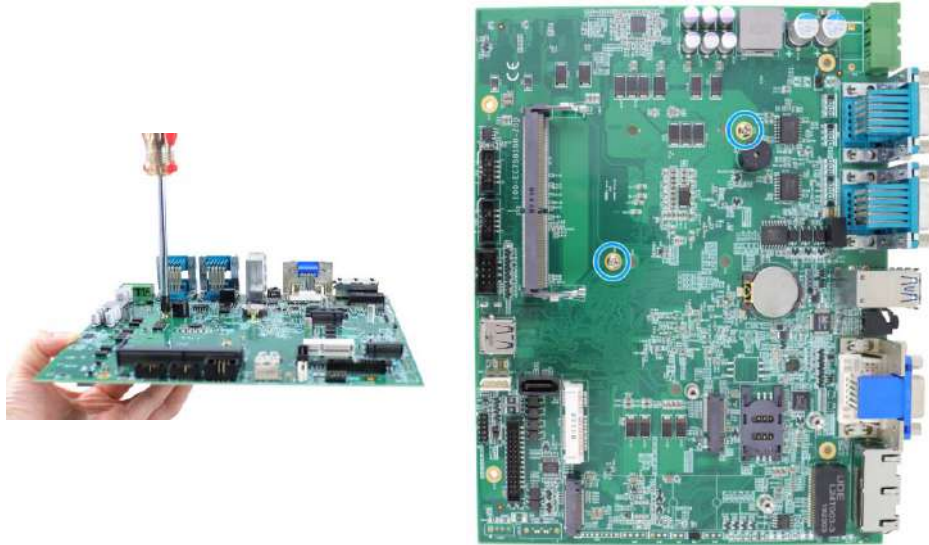

Hold CPU bracket firmly and turn the motherboard around

Secure two M3 P-head screws

7. Remove all protective films on the thermal pads on the heatsink.

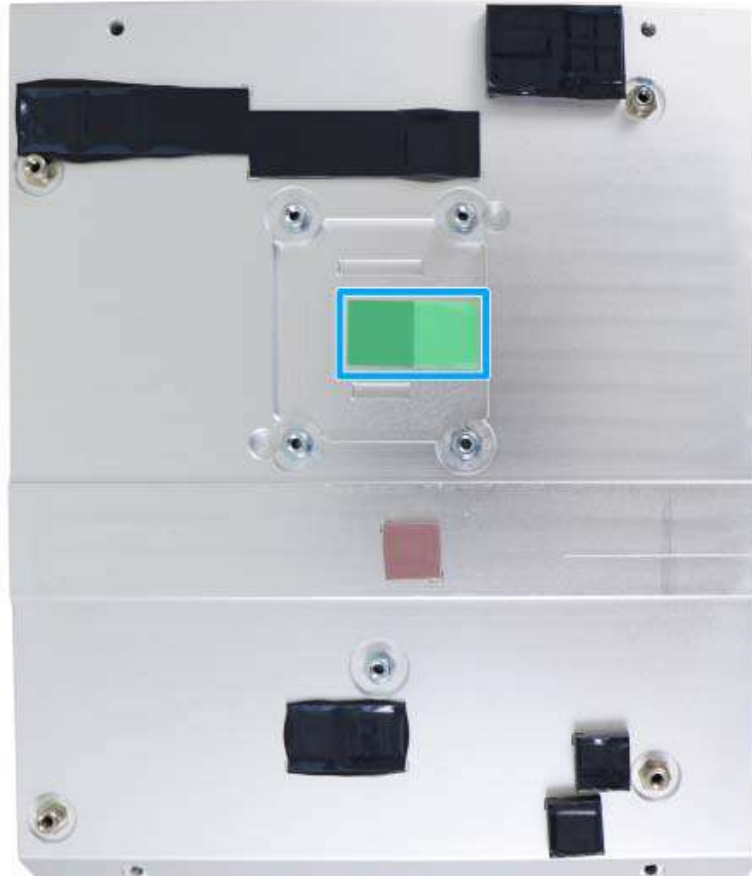

8. With the four motherboard standoffs aligned, gently lower the motherboard onto the heatsink.

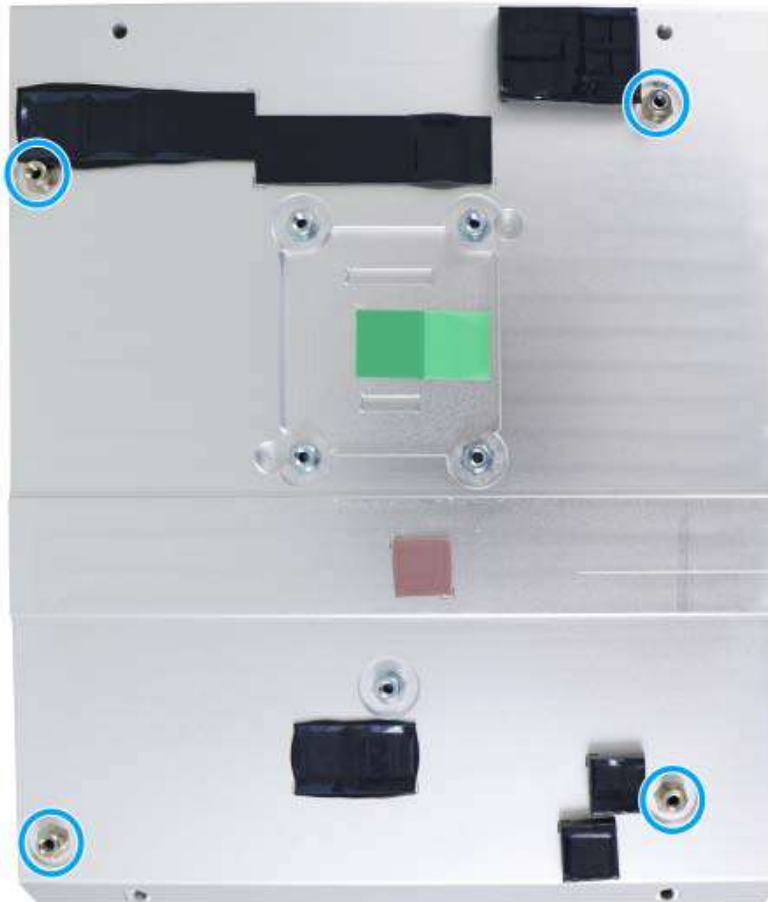

- Secure the four (4) M3 P-head motherboard screws (indicated in **blue**) and from the accessory box, five (5) M3 spring screws (indicated in **red**). Gradually tighten the five screws in the following order for even pressure.



Securing the motherboard



Secure five CPU/ heatsink spring screws in order

- [Reinstall the system enclosure](#) and panel when done.

If you need to install other components, please refer to respective sections.

3.3 DDR4 SO-DIMM Installation

There is a single memory SO-DIMM slot on the motherboard that supports up to 32GB DDR4-2666/ 2400. Please follow the procedures below to replace or install the memory modules.

1. Please refer to the section "[Disassembling the System](#)", you may not need to completely dismantle the system to gain access to the memory module slots.
2. Locate the SODIMM memory module slot on the motherboard.
3. To install the memory module, insert gold fingers of the module into the slot at 45 degree angle, push down on the edge of the module and the clips on the side should clip the module into position.

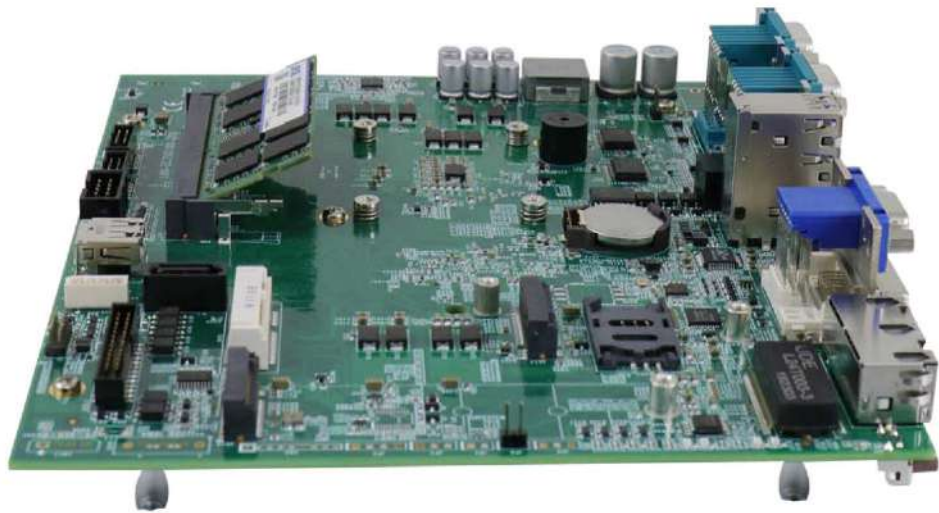

4. Push the memory module down until it is clipped-in.



- When reinstalling the enclosure, please make sure the protective film on the thermal pad (located on the hard drive bracket) has been removed so it can properly make contact with the DRAM module.



- [Reinstall the system enclosure](#) and panel when done.
If you need to install other components, please refer to respective sections.

3.4 M.2 2280 SATA SSD Installation

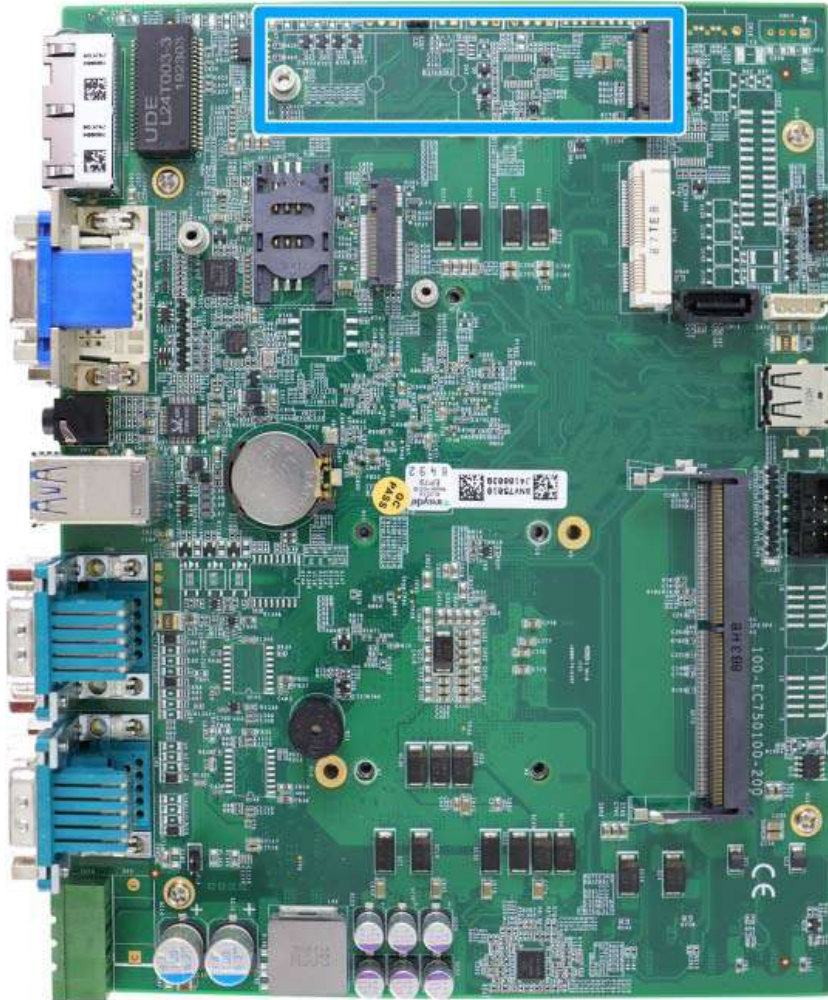

The system has an M.2 2280 slot (SATA signal only) for you to install an M.2 2280 SATA SSD for fast read and write performance. For installation, please refer to the following instructions.

1. Please refer to the section "[Disassembling the System](#)", you may not need to completely dismantle the system to gain access to the M.2 slot.
2. Insert the module on a 45 degree angle.



3. Gently press down and secure the module with an M3 P-head screw.



4. [Reinstall the system enclosure](#) and panel when done.
5. If you need to install other components, please refer to respective sections.

3.5 M.2 Module Installation

The system has a M.2 slot (indicated in **blue**) coupled with SIM socket (indicated in **red**) for installing 3G/ 4G module. For installation, please refer to the following instructions.

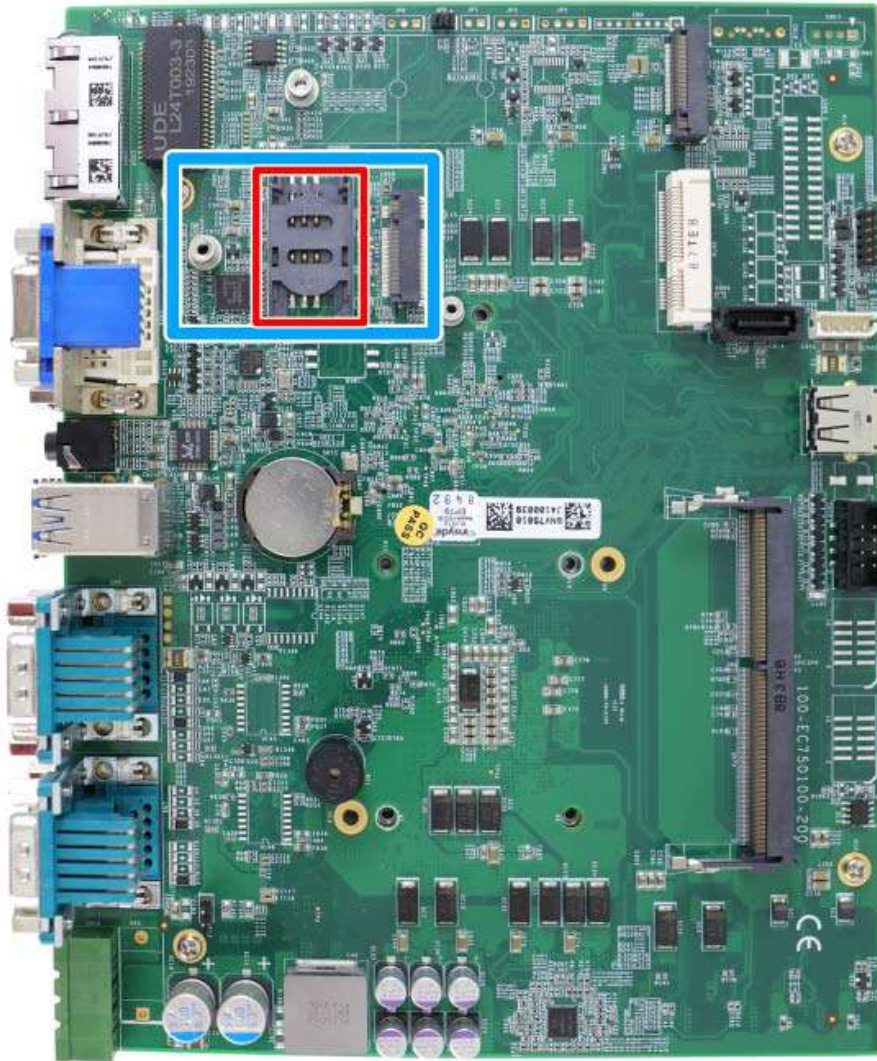

1. Please refer to the section "[Disassembling the System](#)", you may not need to completely dismantle the system to gain access to the M.2 slot and SIM socket.

2. Before installing the M.2 module, you need to insert the SIM card. Slide the SIM slot towards the outside of the motherboard and lift the SIM card holder. Insert the SIM card (pins facing up), and slide it towards the left to lock the SIM card in-place.

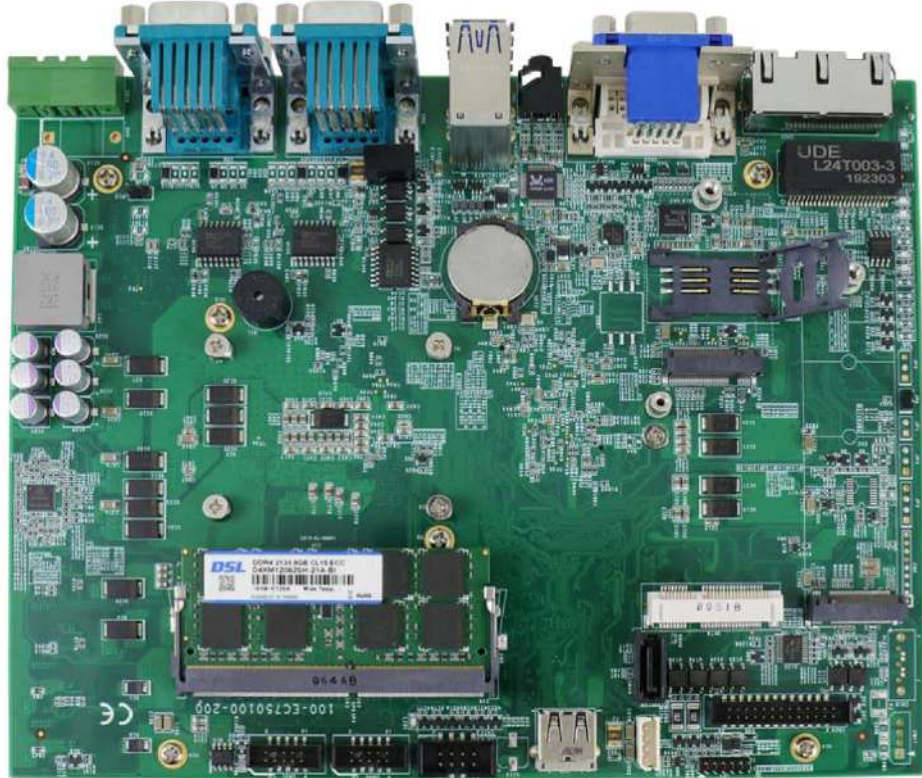

3. Shut the SIM holder and secure it by sliding the holder towards the center of the motherboard.



4. Insert the M.2 module on a 45 degree angle into the M.2 slot.
5. Secure the M.2 module.

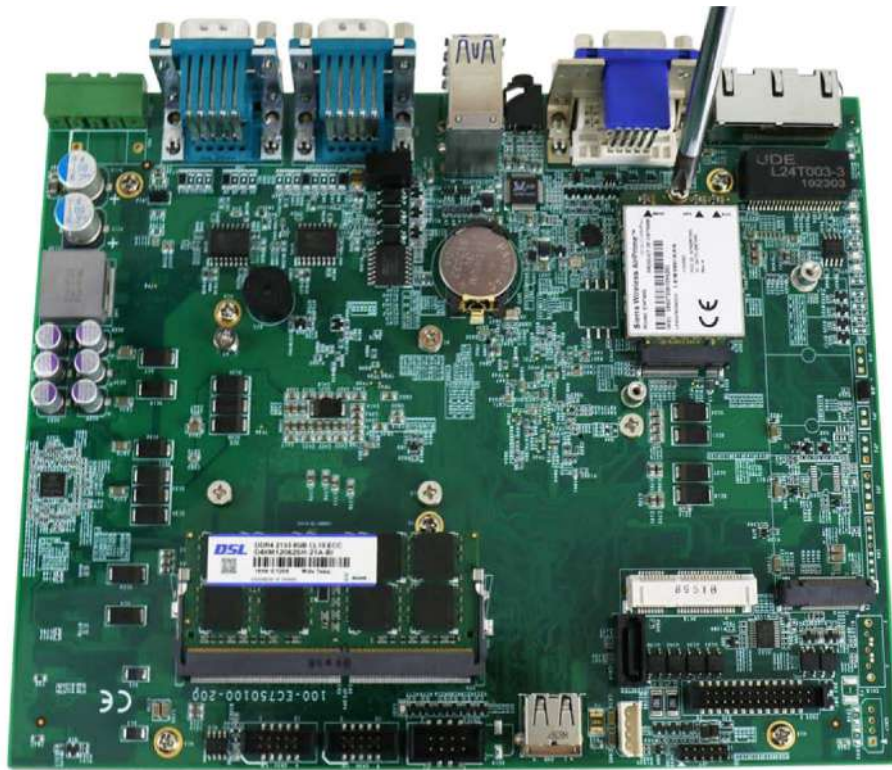

6. Clip on the IPEZ-to-SMA cable to the module (please refer to the module's user manual on antennae cable connection)
7. Secure the antenna to the enclosure panel.

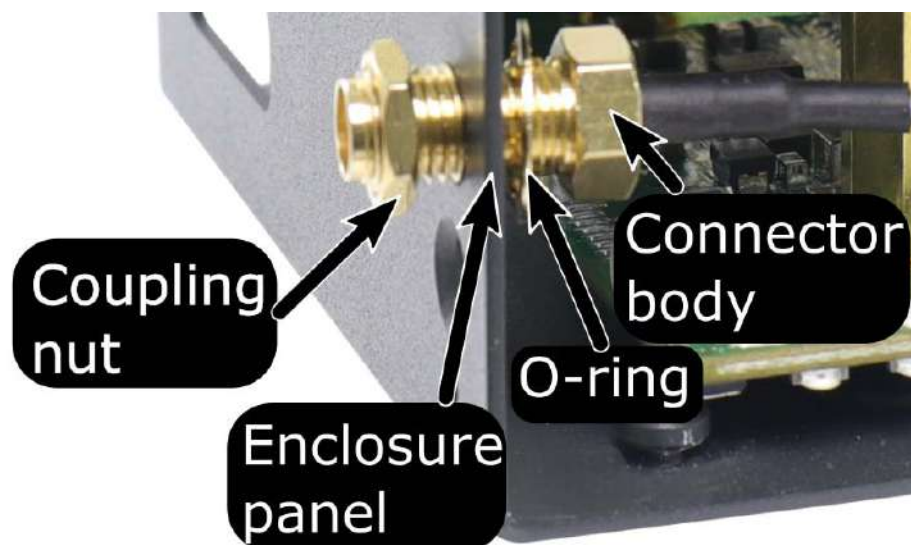

8. [Reinstall the system enclosure](#), panel and attach the external antenna.



If you need to install other components, please refer to respective sections.

3.6 mini-PCle Module Installation

The system has one mini-PCle slot. To install a mini-PCle module, please refer to the following instructions.

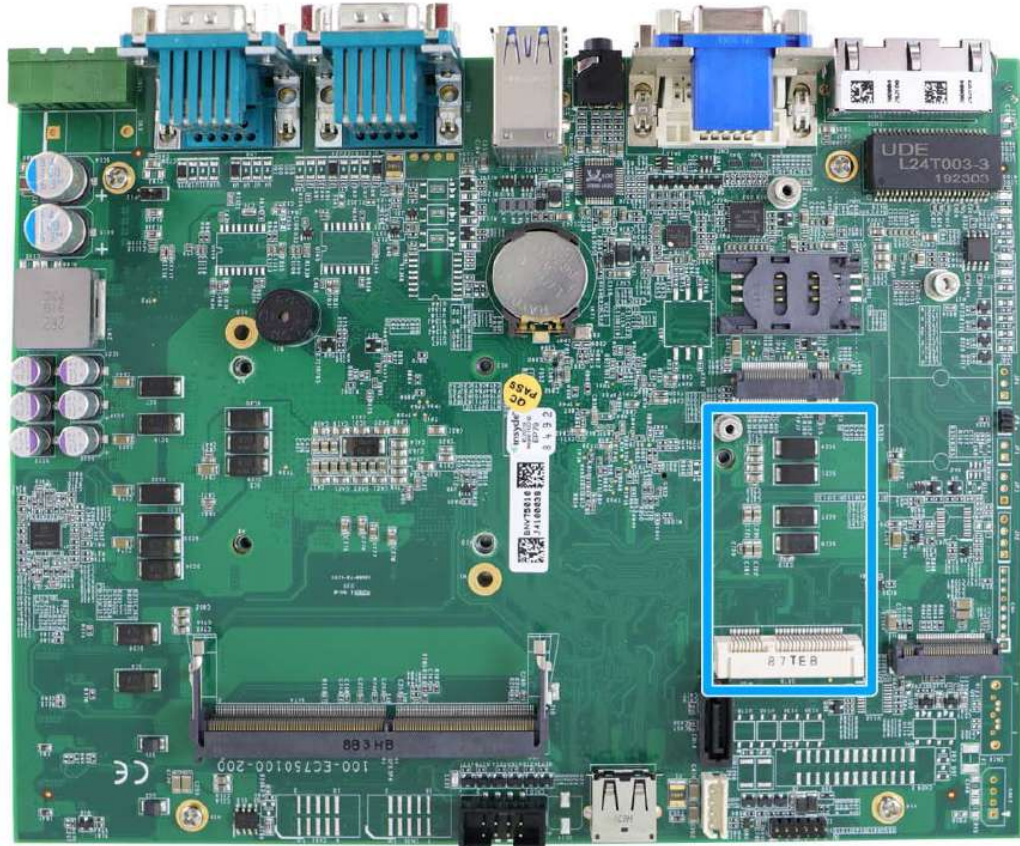

1. Please refer to the section "[Disassembling the System](#)", you may not need to completely dismantle the system to gain access to the mini-PCle slot.
2. Insert the module on a 45 degree angle.



3. Gently press down and secure the module with two M2.5 P-head screws

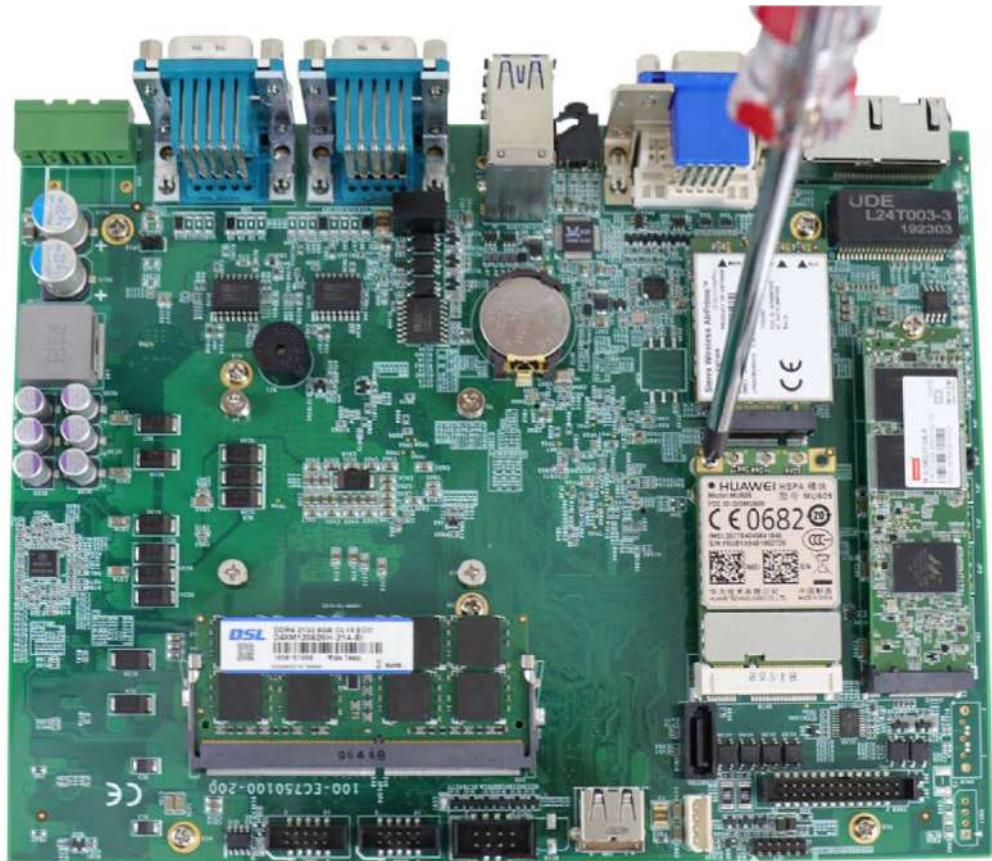

4. Clip on the IPEZ-to-SMA cable to the module and secure the antenna to the side panel. Please refer to the module's manual for clip-on connection.
5. Secure antenna to side panel

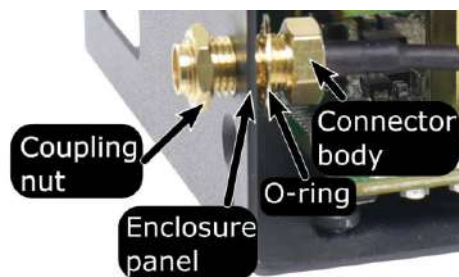

Secure on side panel

Antenna installation

6. [Reinstall the system enclosure](#), panel and external antenna.

If you need to install other components, please refer to respective sections.

3.7 HDD/ SSD Installation

The system has one SATA port, you can install a 2.5" HDD/ SSD or a 3.5" HDD into the system. Please refer to the following instructions:

3.7.1 2.5" HDD/ SSD Installation

1. Please refer to the section "[Disassembling the System](#)" to gain access to SATA port.
2. Secure 2.5" HDD/ SSD on the HDD/SSD bracket with 4 M3 flat-head screws. The area indicated in blue is the protective film on the thermal pad for the DRAM module. The protective film should be removed with the installation of the DRAM module.



3. Secure 2.5" HDD/ SSD and the bracket onto the chassis with M3 flat head screw.



- Connect 2.5" HDD/ SSD to the motherboard with SATA (indicated in **blue**) and power (indicated in **red**) cable.

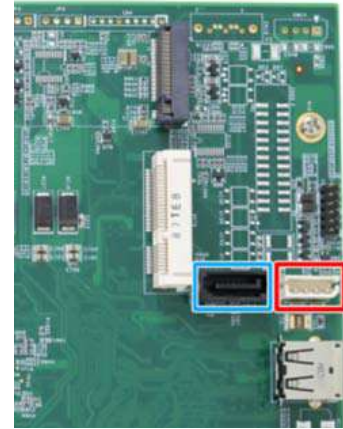
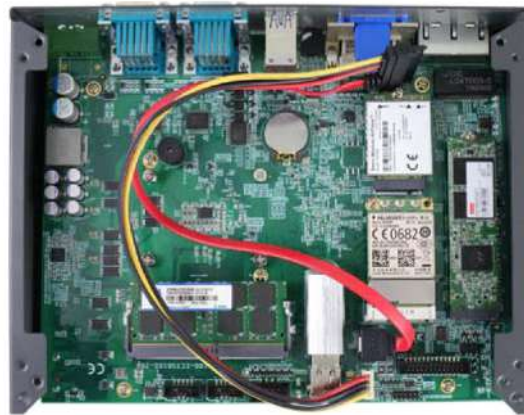

Cable connections

SATA/ power connectors



- [Reinstall the system enclosure](#) and panel when done.

If you need to install other components, please refer to respective sections.

3.7.2 3.5” HDD Installation

1. Please refer to the section “[Disassembling the System](#)” to gain access to SATA port.
2. Secure 3.5” HDD on the HDD/SSD bracket with #6-32 flat-head screws.



3. Secure 3.5” HDD and the bracket on the chassis with M3 flat head screw.



- Connect 3.5" HDD/ SSD to the motherboard with SATA (indicated in **blue**) and power (indicated in **red**) cable.

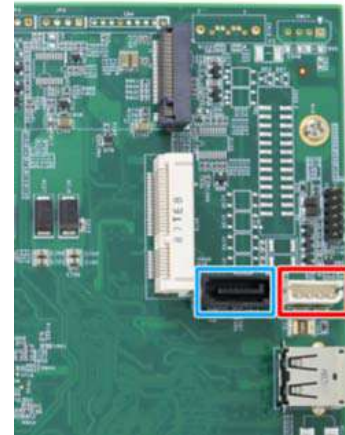
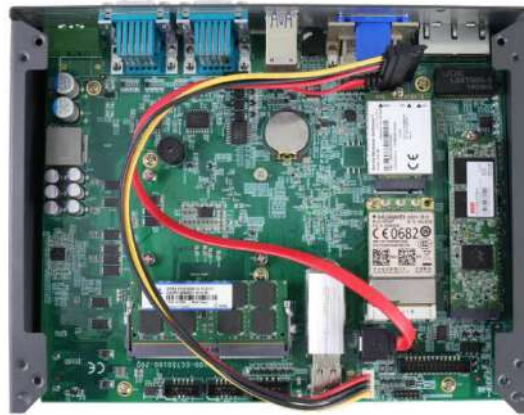

Cable connections

SATA/ power connectors



- [Reinstall the system enclosure](#) and panel when done.

If you need to install other components, please refer to respective sections

3.8 Installing the System Enclosure

To reinstall the system enclosure, please follow the steps below:

1. For Nuvo-7505D system, connect the DIO and COM port cable onto the motherboard connector (indicated in blue).

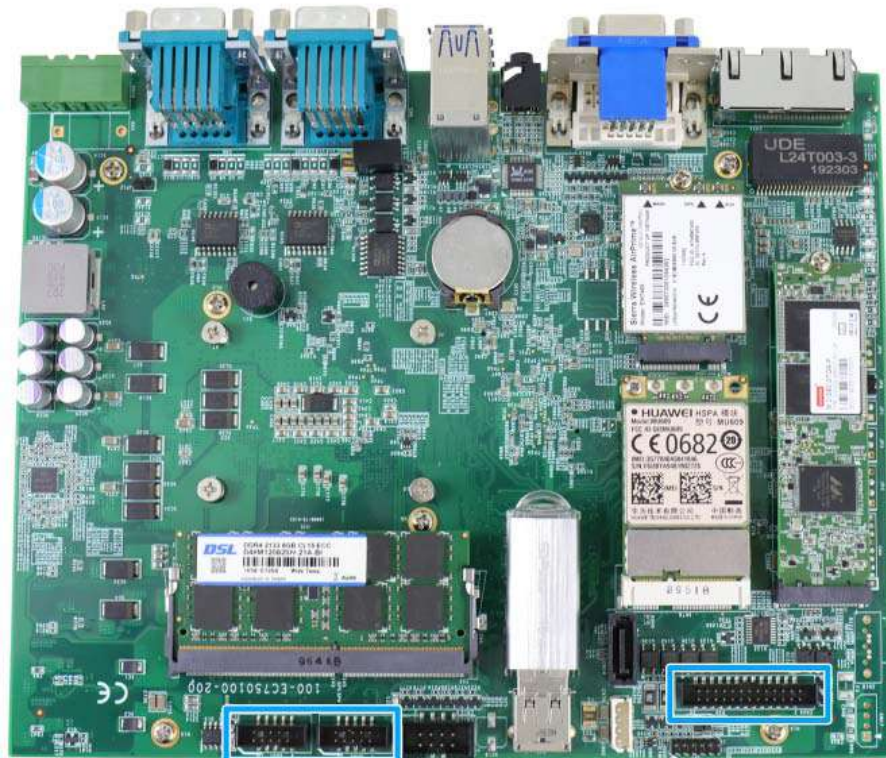

2. With the heatsink upside-down, gently lower the enclosure.
3. Place the four rubber stand and secure the four (4) screws at the bottom of the system panel.



- Secure the three (3) screws on the rear panel.



- Turn the system around with the heatsink on top, secure the four(4) screws at the top of the enclosure.



- Secure the three(3) screws on the IP panel to complete the enclosure installation procedure.



3.9 Mounting Nuvo-7501 Series

Neosys provides versatile mounting methods for Nuvo-7501 series systems. You can use built-in wall-mounting brackets to mount it on the wall. Neosys also offers optional DIN-rail mounting kit to mount it on a DIN-rail. To mount your Nuvo-7501 controller, please refer to the instructions listed below.

3.9.1 Wall-mounting Nuvo-7501 Series

Nuvo-7501 systems have built-in wall-mounting brackets as the standard mounting option. Please follow steps below to mount your Nuvo-7501 controller on a flat surface.

1. Please refer to the following wall-mount screw hole measurements and fix it on a flat surface.

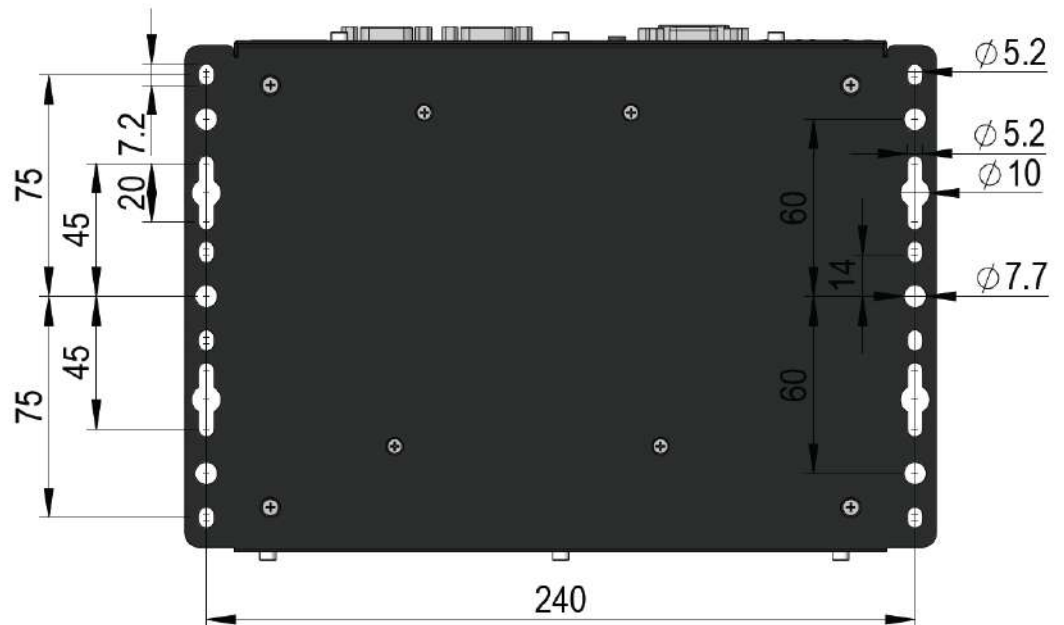

3.9.2 Installing DIN-Rail Mounting Kit (Optional)

The kit includes a bracket and a DIN-rail mounting clip. You should fix the clip to the bracket using four M4 flat-head screws first, and then fix the bracket assembly to the Nuvo-7501 controller with another four M4 screws. This option can be useful if you want to deploy it inside an equipment cabinet where DIN-rail is available.

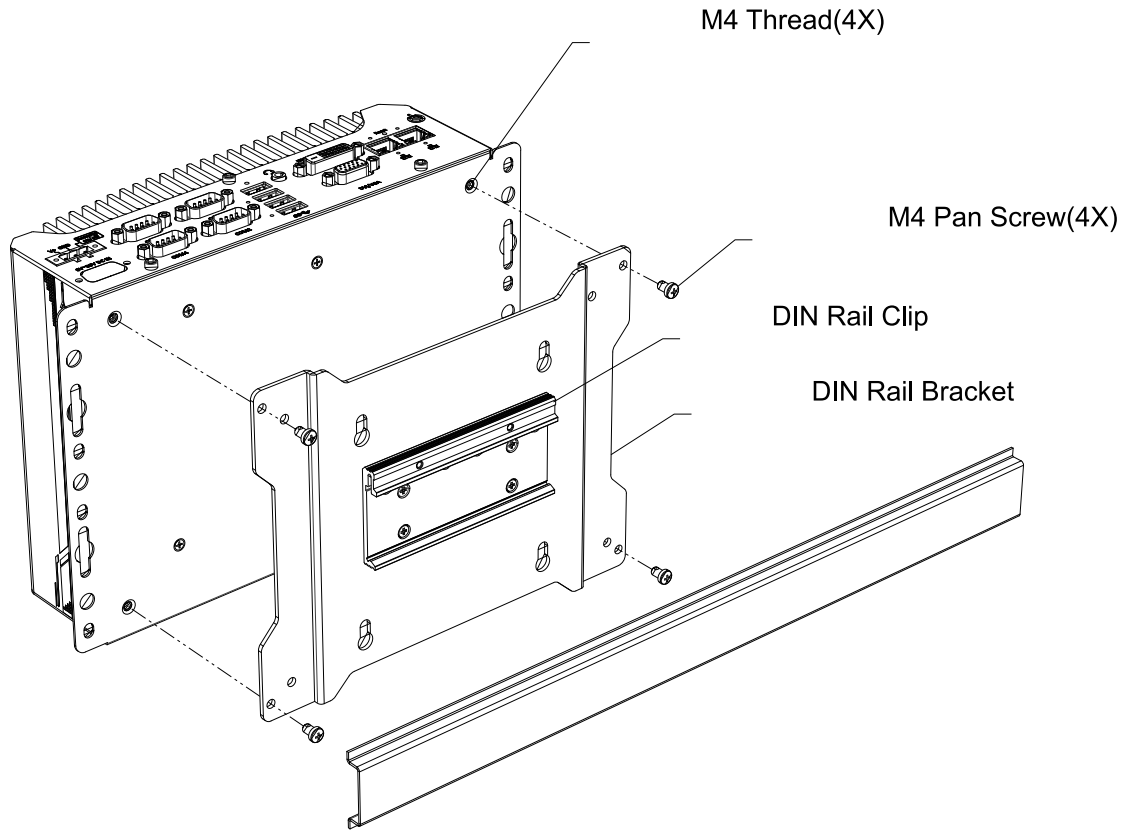

4 System Configuration

4.1 BIOS Settings

The system is shipped with factory-default BIOS settings meticulously programmed for optimum performance and compatibility. In this section, we'll illustrate some of BIOS settings you may need to modify. Please always make sure you understand the effect of change before you proceed with any modification. If you are unsure of the function you are changing, it is recommended to change one setting at a time to see its effect(s).



 **NOTE**

Not all BIOS settings will be discussed in this section. If there is a particular BIOS setting you are after but is not discussed in this section, please contact Neousys Technical Support staff.

4.1.1 COM Port Configuration

There are four COM ports for Nuvo-7501 and six COM ports for Nuvo-7505D. The system's COM1 and COM2 support RS-232 (full-duplex), RS-422 (full-duplex) and RS-485 (half-duplex) mode, while COM3 and COM4 support RS-232 mode only. You can set the COM1/ COM2 operating mode via BIOS settings.

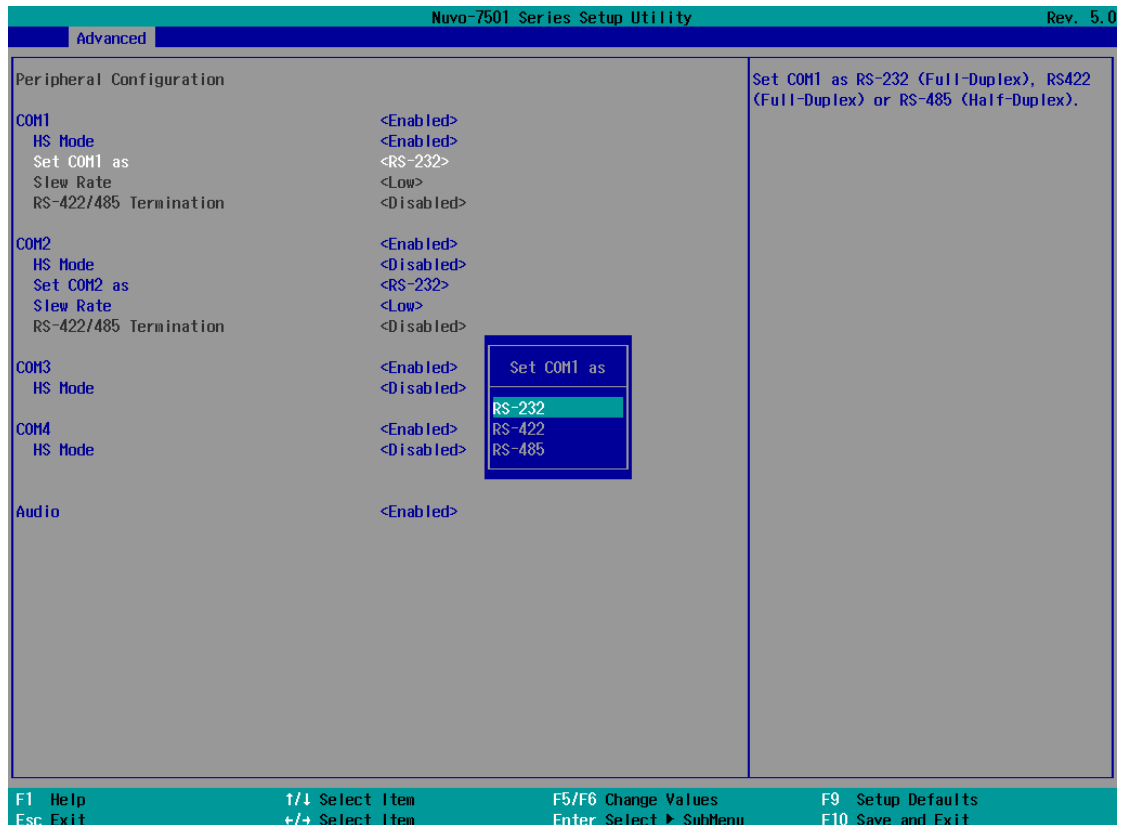

Another option in the BIOS called “**Slew Rate**” defines how sharp the rise/ fall edge is for the output signal of COM1/ COM2. For long-distance RS-422/ 485 transmission, you may set the “**Slew Rate**” option as “High” to improve signal quality.



Screen shot of Nuvo-7505D with 6 COM ports

For RS-422/485 communication, the “**RS-422/485 Termination**” option determines whether to enable/disable internal termination of RS-422/485 transceiver according to your wiring configuration (e.g. with or without external termination).

To set COM port operating mode:

1. When system boots up, press F2 to enter BIOS setup utility.
2. Go to **[Advanced] > [Peripheral Configuration]**.
3. Highlight the COM port you wish to set and press Enter to bring up setting options. Scroll to and highlight the setting you wish to set and press Enter.
4. Repeat step 2 to set other COM ports.

Press F10 to “Exit Saving Changes”.

4.1.2 COM Port High Speed Mode

The high speed mode of each COM port effectively allows for the port's baud rate generator to operate at 8x the speed with an effective baud rate of 921,600 bps (115,200 x 8). Please refer to the following instructions on how to enable the high speed mode for your COM port (COM1 used as an example).

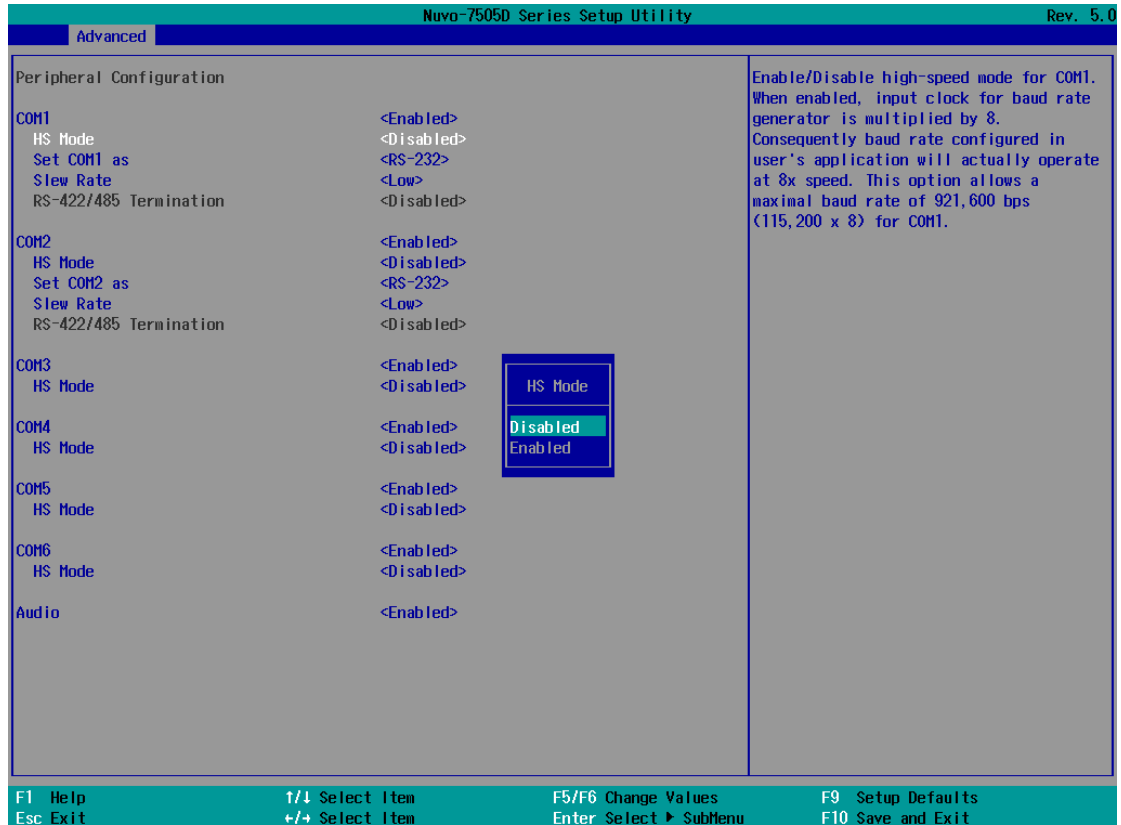

To set COM port high speed mode:

1. Press **F2** when the system boots up to enter the BIOS setup utility.
2. Go to **[Advanced] > [Peripheral Configuration]**.
3. Enable or set the **[Set COM1 Mode as]** option to the desired mode.
4. Highlight **[HS Mode]** and press ENTER to bring up options, highlight **[Enable]** and press ENTER.
5. Once set, press **F10** to save setting and exit.

4.1.3 Power On After Power Failure Option

This option defines the behavior of system when DC power is supplied.

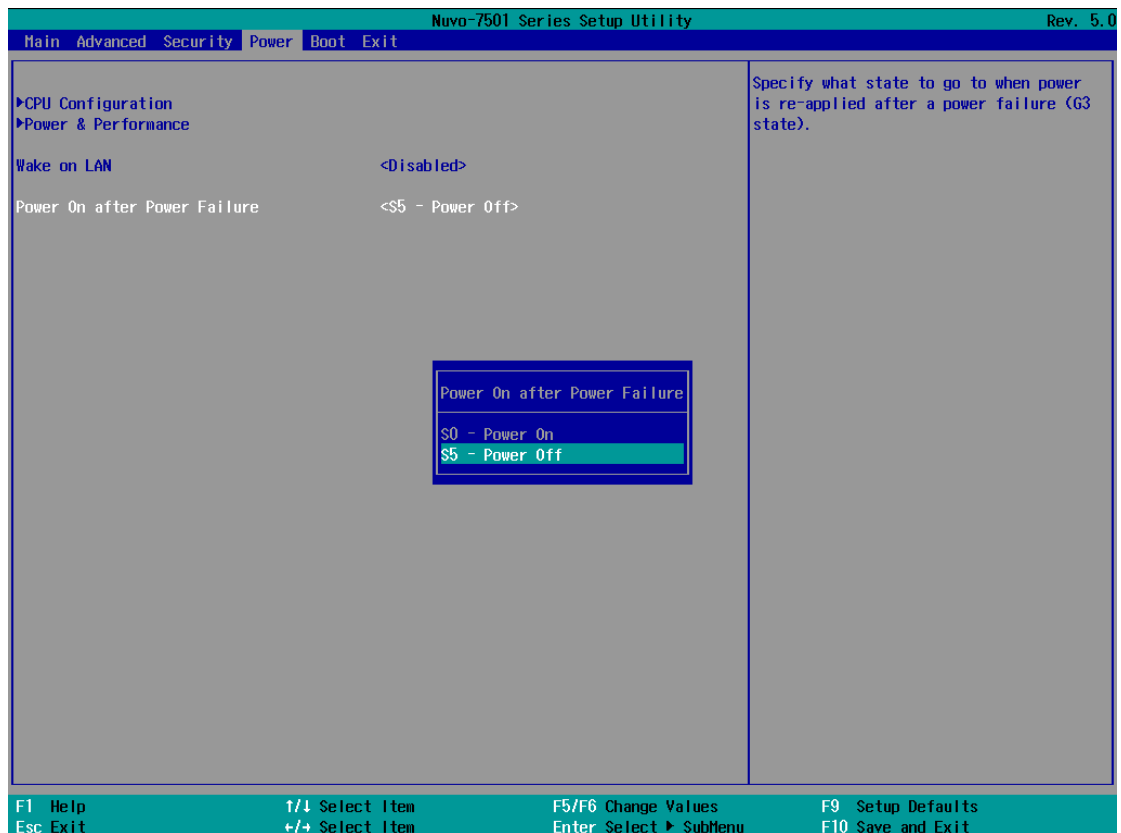

Value	Description
S0 – Power On	System is powered on when DC power is supplied.
S5 – Power Off	System is kept in off state when DC power is supplied.

To set “Power On after Power Failure” option:

1. When system boots up, press F2 to enter BIOS setup utility.
2. Go to **[Power] > [Power On after Power Failure]**.
3. Scroll down to highlight **[Power On after Power Failure]**, press Enter to bring up setting options, S0 – Power On or S5 – Power Off, and press Enter to select the setting.
4. Press F10 to “Exit Saving Changes”.

4.1.4 SATA Configuration

The system SATA controller supports two (2) operating modes: **SATA** and **AHCI** modes. **AHCI** mode, which exposes SATA's advanced capabilities such as hot swapping and native command queuing, is supported in several later version of operating systems.



Recommended SATA controller mode settings:

- If you're using Windows Vista, Windows 7/ 8/ 10, or Linux kernel 2.6.19 or later, you can select **AHCI** mode for better performance.

To set SATA controller mode:

1. When system boots up, press F2 to enter BIOS setup utility.
2. Go to **[Advanced] > [SATA and RST Configuration] > [SATA Mode Selection]**.
3. Highlight **AHCI** and press Enter to bring up setting options.
4. Use the up/ down arrow keys and go to **[SATA Device Type]** and highlight "Hard Disk Drive" or "Solid State Drive" and press Enter to select your option.
5. Press F10 to "Exit Saving Changes".

4.1.5 Power & Performance (CPU SKU Power Configuration)

The system supports Intel 9th/8th Gen Coffee Lake LGA1151 CPUs. A unique feature, “**SKU Power Config**” is implemented in BIOS to allow users to specify user-defined SKU power limit. Although the system is designed to have best thermal performance with CPUs of 35W TDP, you can install a 65W CPU and limit its SKU power to 35W to obtain more computing power. This feature gives you the flexibility of CPU selection and great balance between computing power and operating temperature range.

To configure the CPU SKU power limit:

1. When the system boots up, press F2 to enter BIOS setup utility.
2. Go to **[Power]** → **[Power & Performance]**.

Select a proper value of SKU power limit for **[SKU Power Config]** option.

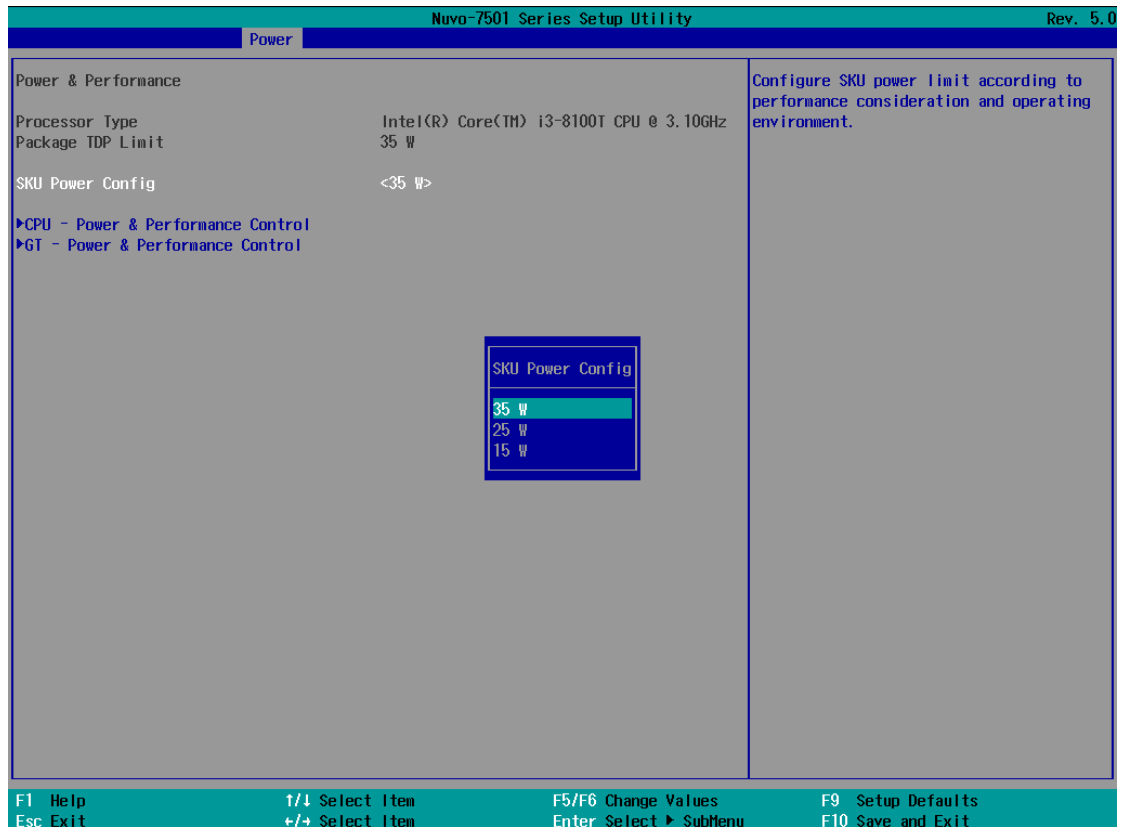

4.1.6 Wake on LAN Option

Wake-on-LAN (WOL) is a mechanism which allows you to turn on your system via Ethernet connection. To utilize Wake-on-LAN function, you have to enable this option first in BIOS settings. Please refer to “Powering On Using Wake-on-LAN” to set up the system.

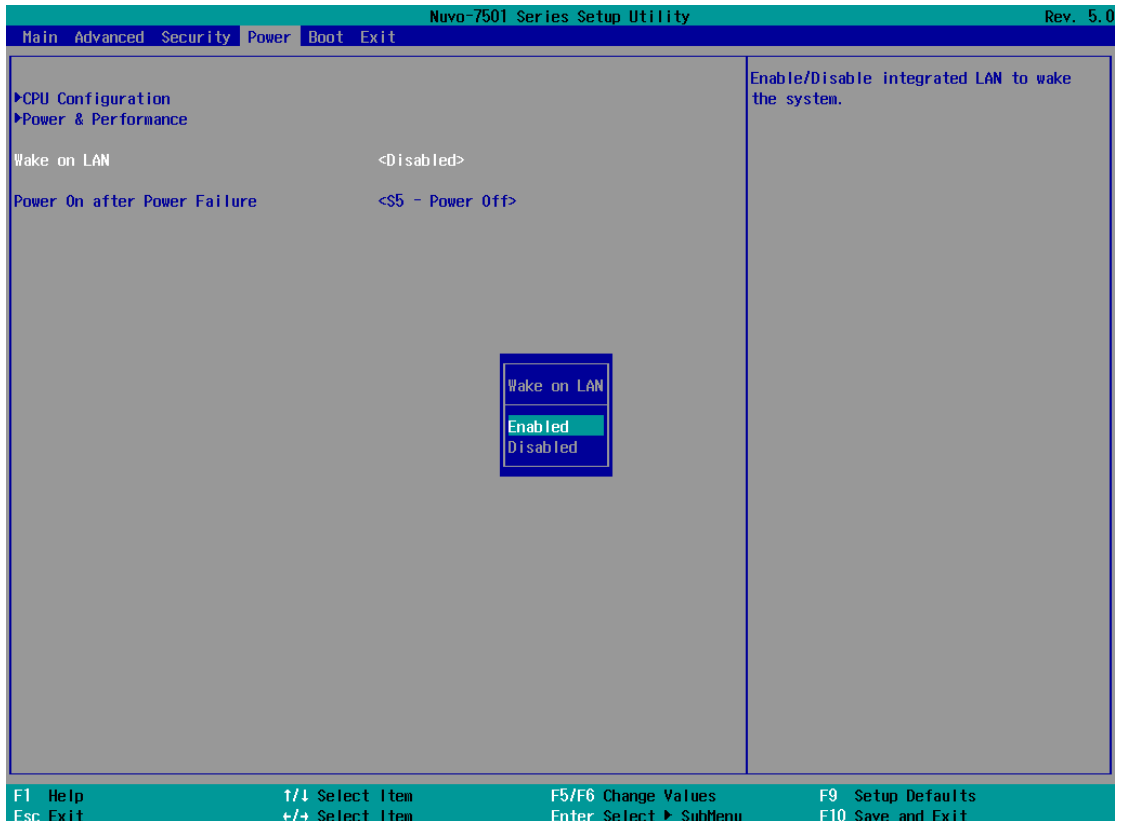

To enable/disable “Wake on LAN” option:

1. When system boots up, press F2 to enter BIOS setup utility.
2. Go to **[Power] > [Wake on LAN]**.
3. Press Enter to bring up setting options, scroll to the setting you desire and press Enter to set.
4. Press F10 to “Exit Saving Changes.”

4.1.7 Boot Menu

The Boot menu in BIOS allows you to specify the system’s boot characteristics by setting bootable device components (boot media) and method. Or, you may press F12 upon system start up and select a device you wish boot from.



4.1.8 Boot Type (Legacy/ UEFI)

The system supports both Legacy and Unified Extensible Firmware Interface (UEFI) boot modes. UEFI is a specification proposed by Intel to define a software interface between operating system and platform firmware. Most modern operating systems, such as Windows 7/8/10 and Linux support both Legacy and UEFI boot modes. The Legacy boot mode uses MBR partition for disk and VBIOS for video initialization, the UEFI boot mode uses GPT partition which supports greater than 2TB partition size and GOP driver for faster video initialization.



It is recommended that:

- If you need greater than 2TB disk partition, you shall choose UEFI boot mode and install operating system accordingly.
- Choose Legacy boot mode if the installed HDD/ SSD capacities are under 2TB

To configure Boot Type:

1. When system boots up, press F2 to enter BIOS setup utility.
2. Go to **[Boot] > [Boot Type]**, press Enter to bring up options, Dual Boot (Legacy+UEFI), Legacy Boot Type, UEFI Boot Type.
3. Highlight your selection and press Enter.
4. Press F10 to “Exit Saving Changes”.

4.1.9 Add Boot Options

The Add Boot Options dedicates the boot sequence order of a newly added device (eg. USB flash drive). The setting allows you to set the newly added device to boot first or as the last device on the list.

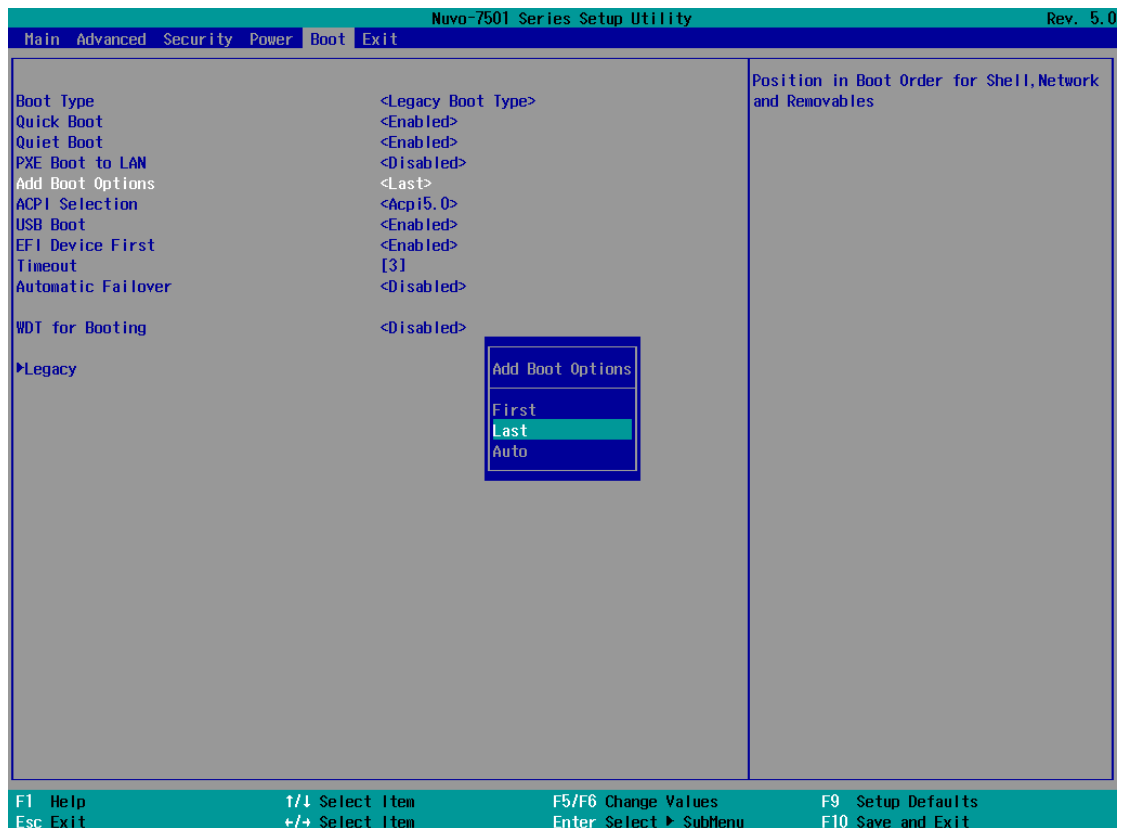

To set Add Boot Options:

1. When system boots up, press F2 to enter BIOS setup utility.
2. Go to [Boot] > [Add Boot Option], press Enter to bring up options, First or Last.
3. Highlight your selection and press Enter, press F10 to "Exit Saving Changes".

4.1.10 Watchdog Timer for Booting

The Watchdog timer setting in the BIOS ensures a successful system boot by specifying a timeout value. If the Watchdog timer is not stopped and expires, the BIOS will issues a reset command to initiate another boot process. There are two options in BIOS menu, “**Automatically after POST**” and “**Manually after Entering OS**”. When “**Automatically after POST**” is selected, the BIOS automatically stop the watchdog timer after POST (Power-On Self Test) OK. When “**Manually after Entering OS**” is selected, it’s user’s liability to stop the watchdog timer when entering OS. This guarantees the system can always boot into OS, otherwise another booting process will be initiated.

For information about programming watchdog timer, please refer to **Appendix A Watchdog Timer & Isolated DIO**.

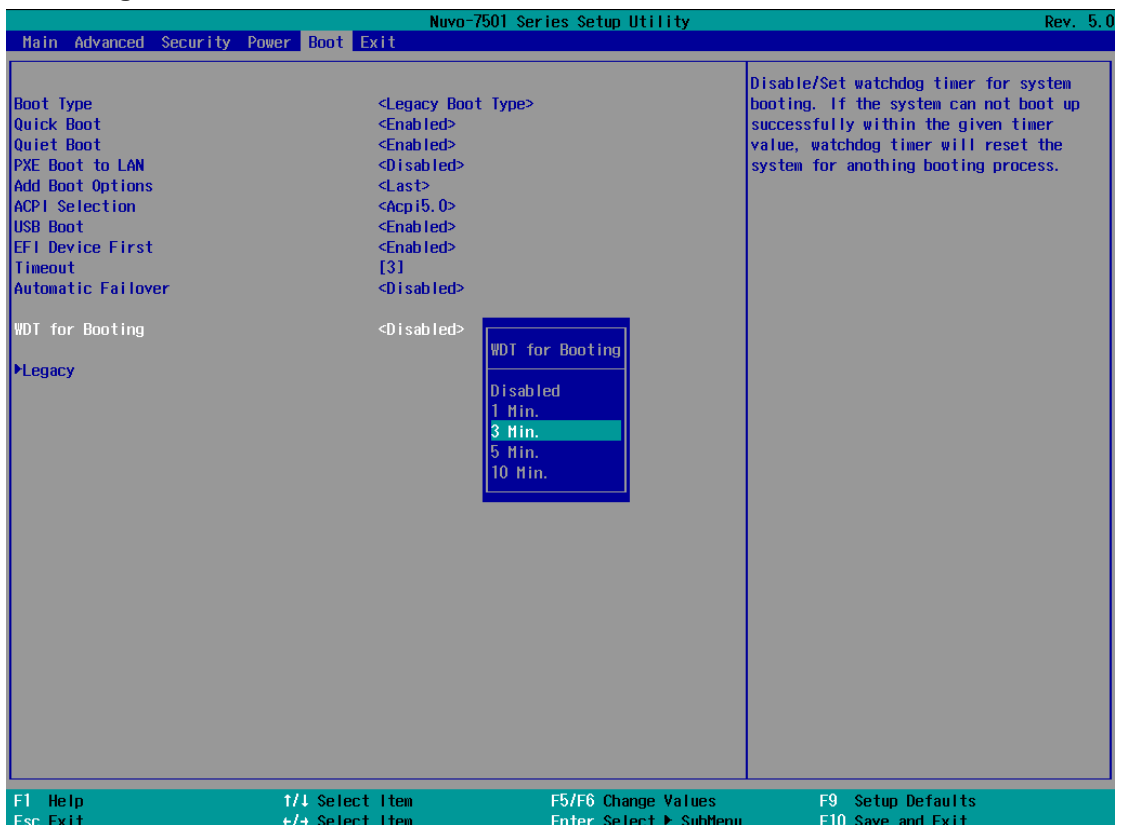

To set the watchdog timer for boot in BIOS:

1. When system boots up, press F2 to enter BIOS setup utility.
2. Go to **[Boot]** menu.
3. Disable or select timeout value for **[WDT for Booting]** option.
4. Once you give a timeout value, the **[WDT Stop Option]** option appears. You can select “*Automatically after POST*” or “*Manually after Entering OS*”.
5. Press F10 to “Exit Saving Changes.

4.1.11 Legacy/ UEFI Boot Device

When you wish to set a designated boot device, you may set it as the first device to boot in Legacy or UEFI Boot Device setting. Or if you wish to manually select a boot device, you may do so by pressing F12 when the system boots up.

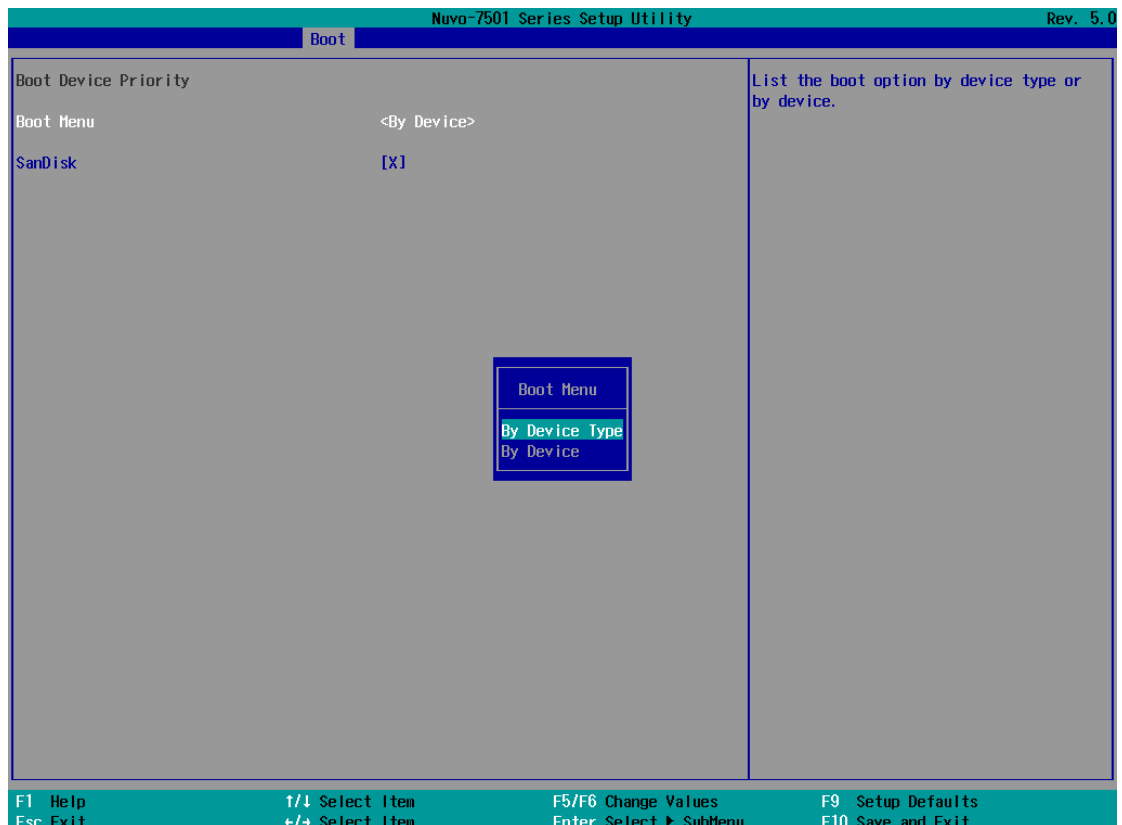

To set boot order for devices in UEFI Boot Device:

1. When system boots up, press F2 to enter BIOS setup utility
2. Go to **[Boot] > [UEFI Boot Device]**
3. Highlight the device you wish to make boot order changes to and press F5/ F6 or +/- to change device boot order.

To select boot order for devices in Legacy Boot Device:

1. When system boots up, press F2 to enter BIOS setup utility
2. Go to **[Boot] > [Legacy Boot Device]**, you can choose the type of device to list by selecting **"By Device or By Device Type"**.
3. Highlight the device you wish to make boot order changes to and press F5/ F6 or +/- to change device boot order.

5 OS Support and Driver Installation

5.1 Operating System Compatibility

The system supports most operating system developed for Intel® x86 architecture. The following list contains operating systems that have been tested by Neosys Technology.

- Microsoft Window 10 (x64)
- Fedora 29**
- Ubuntu 16.04.5 LTS and 18.04.0 LTS**



NOTE

For other Linux OS, Linux kernel should upgrade to 4.15.18.

** For Linux system, user may need to manually compile and install the driver for Intel graphics or I210 GbE controller if the driver is not embedded in kernel. You can visit Intel website for further information.*

*** For distributions, graphics driver and RAID function may not be completely implemented in its kernel. You may encounter restrictions when using these features, such as triple independent display and RAID. For optimum operation, it is the users' responsibility to manually check for new drivers and upgrades!*

Neosys may remove or update operating system compatibility without prior notice. Please contact us if your operating system of choice is not on the list.

5.2 Driver Installation

The system comes with a “Drivers & Utilities” DVD that offers “one-click” driver installation process. It automatically detects your Windows operating system and installs all necessary drivers for you system with a single click.

5.3 Install Drivers Automatically

To install drivers automatically, please refer to the following procedures.

1. Insert the “Drivers & Utilities” DVD into a USB DVD-drive connect to your system. A setup utility launches and the following dialog appears.



Click on “**Automatic Driver Installation**” and the setup utility will automatically detect your Windows operating system and install all necessary drivers. The installation process takes about 6~8 minutes depending on your Windows version. Once driver installation is done, the setup utility reboots your Windows and you may begin using your system.

5.4 Install Drivers Manually

You can also manually install each driver for the system. Please note when installing drivers manually, you need to install the drivers in the following sequence mentioned below.

5.4.1 Windows 10 (x64)

The recommended driver installation sequence is

1. Chipset driver (x:\Driver_Pool\Chipset_CFL\Win_10_64\SetupChipset.exe)
2. Graphics driver
(x:\Driver_Pool\Graphics_CFL_SKL_APL\Win_10_64\igxpin.exe)
3. Audio driver (x:\Driver_Pool\Audio_ALC262\Win_ALL_64\Setup.exe)
4. LAN driver
(x:\Driver_Pool\GbE_I210_I350\Win_10_64_CFL\APPS\PROSETDX\Winx64\
DxSetup.exe)
5. ME driver (x:\Driver_Pool\ME_CFL\Win_10_64\SetupME.exe)

5.5 Driver Installation for Watchdog Timer Control

Neosys provides a driver package which contain function APIs for Watchdog Timer control function. You should install the driver package (WDT_DIO_Setup.exe) in prior to use these functions. Please note that you must install WDT_DIO_Setup_v2.2.9.8 or later versions.

5.5.1 Windows 10 (x64)

Please execute the driver setup program in the following directory.

x:\Driver_Pool\WDT_DIO\Win7_8_10_64\WDT_DIO_Setup_v2.2.9.8(x64).exe

5.5.2 Windows 10 (WOW64)

Please execute the driver setup program in the following directory.

x:\Driver_Pool\WDT_DIO\Win7_8_10_WOW64\WDT_DIO_Setup_v2.2.9.8(wow64).
exe

Appendix A Using WDT & DIO

Watchdog Timer

The watchdog timer (WDT) function ensures reliable system operation. The WDT is a hardware mechanism to reset the system if the watchdog timer expires. Users can start the WDT and keep resetting the timer to make sure the system or program is running. Otherwise, the system shall be reset.

In this section, we'll illustrate how to use the function library provided by Neosys to program the WDT functions. Currently, WDT driver library supports Windows 10 x64 and WOW64 platforms. For other OS support, please contact Neosys Technology for further information.

Isolated DIO (Nuvo-7505D Only)

The system also features isolated digital I/O is available for extended range of applications. Nuvo-7505D features 8x DI channels and 8x DO channels via a DSub-25 connector. The digital I/O supports standard polling mode I/O access so users' program can read or write DIO channel(s) using the function library.

WDT and DIO Library Installation

Installing WDT_DIO Library

The WDT_DIO function library is delivered in the form of a setup package named **WDT_DIO_Setup.exe**. Prior to programming WDT, you should execute the setup program and install the WDT library. Please use the following WDT_DIO_Setup packages according to your operating systems and application.

- For Windows 10 64-bit OS with 64-bit application (x64 mode), please install WDT_DIO_Setup_v2.2.9.8(x64).exe or later version.
- For Windows 10 64-bit OS with 32-bit application (WOW64 mode), please install WDT_DIO_Setup_v2.2.9.8(wow64).exe or later version.

To setup WDT & DIO Library, please follow instructions below.

1. Execute **WDT_DIO_Setup.2.2.9.8.exe**. and the following dialog appears.

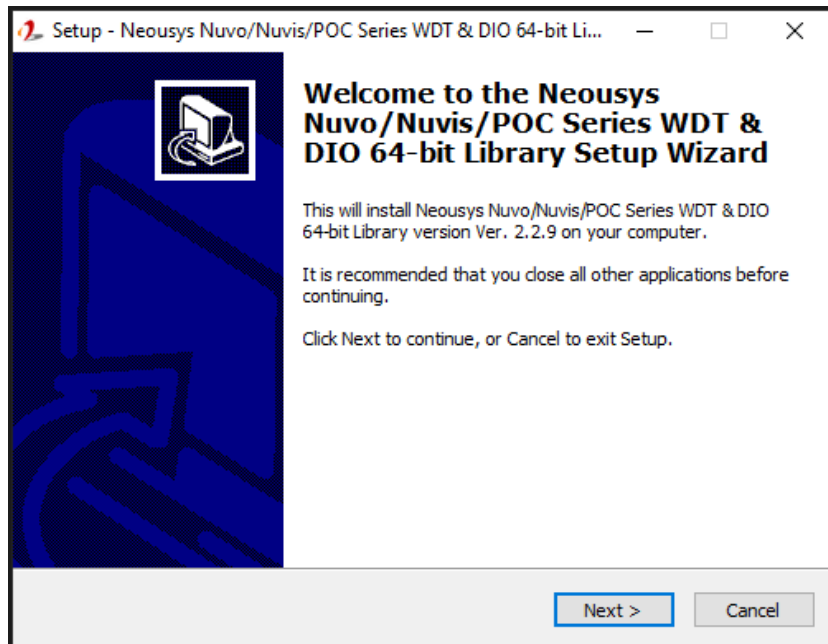

2. Click "Next >" and specify the directory of installing related files. The default directory is *C:\Neosys\WDT_DIO*.

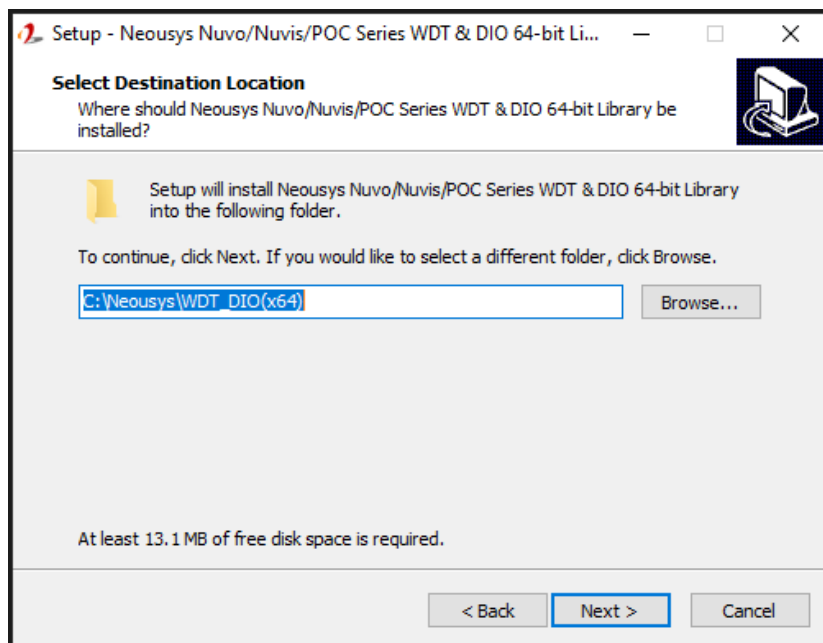

- Once the installation has finished, a dialog will appear to prompt you to reboot the system. The WDT & DIO library will take effect after the system has rebooted.

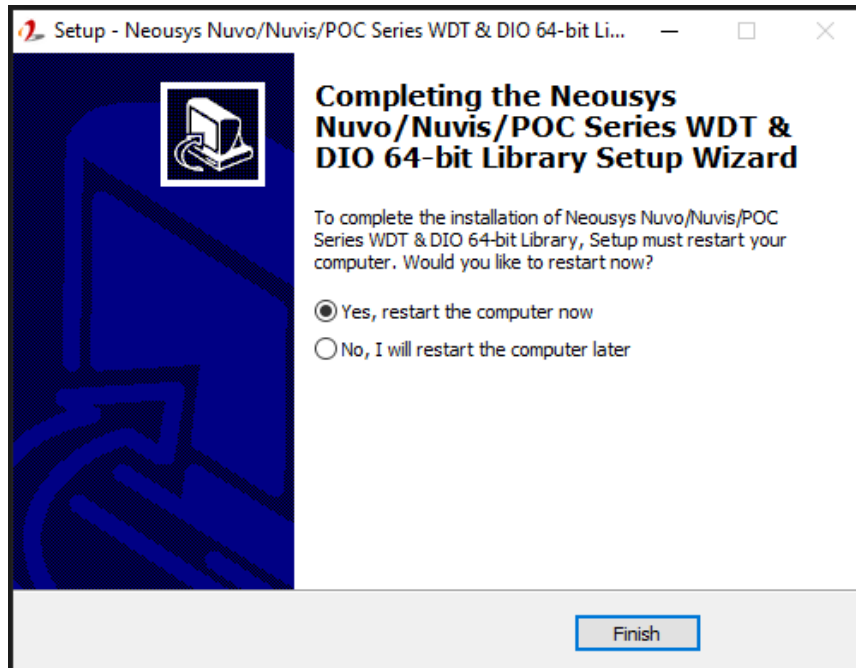

- When programming your WDT or DIO program, the related files are located in

Header File:	\Include
Library File:	\Lib
Function Reference:	\Manual
Sample Code:	\Sample\ WDT_Demo (Demo for Watchdog Timer) \Sample\ DIO_Demo (Demo for Polling I/O)

WDT Functions

InitWDT

Syntax	BOOL InitWDT(void);
Description:	Initialize the WDT function. You should always invoke InitWDT() before set or start watchdog timer.
Parameter	None
Return Value	TRUE: Successfully initialized FALSE: Failed to initialize
Usage	BOOL bRet = InitWDT();

SetWDT

Syntax	BOOL SetWDT(WORD tick, BYTE unit);
Description	Set timeout value and unit for watchdog timer. When InitWDT() is invoked, a default timeout value of 255 seconds is assigned.
Parameter	tick WORD value (1 ~ 65535) to indicate timeout ticks. unit BYTE value (0 or 1) to indicate unit of timeout ticks. 0 : unit is minute 1 : unit is second
Return Value	If value of unit is correct (0 or 1), this function returns TRUE, otherwise FALSE.
Usage	WORD tick=255; BYTE unit=1; //unit is second. BOOL bRet = SetWDT(tick, unit); //timeout value is 255 seconds

StartWDT

Syntax	BOOL StartWDT(void);
Description	Starts WDT countdown. Once started, the WDT LED indicator will begin blinking. If ResetWDT() or StopWDT is not invoked before WDT countdowns to 0, the WDT expires and the system resets.
Parameter	None
Return Value	If the timeout value is given in correct format (WDT started), this function returns TRUE, otherwise FALSE
Usage	BOOL bRet = StartWDT()

ResetWDT

Syntax	BOOL ResetWDT(void);
Description	Reset the timeout value to the value given by SetWDT().If ResetWDT() or StopWDT is not invoked before WDT countdowns to 0, the WDT expires and the system resets.
Parameter	None
Return Value	Always returns TRUE
Usage	BOOL bRet = ResetWDT()

StopWDT

Syntax	BOOL StopWDT(void);
Description	Stops the countdown of WDT. When WDT has stopped, the WDT LED indicator stops blinking.
Parameter	None
Return Value	Always returns TRUE
Usage	BOOL bRet = StopWDT()

DIO Functions

InitDIO

Syntax	BOOL InitDIO(void);
Description	Initialize the DIO function. You should always invoke InitDIO() before write/read any DIO port/channel.
Parameter	None
Return Value	Returns TRUE if initialization successes, FALSE if initialization failed.
Usage	BOOL bRet = InitWDT();

DIReadLine

Syntax	BOOL DIReadLine(BYTE ch);
Description	Read a single channel of isolated digital input.
Parameter	ch BYTE value specifies the DI channel to be read. <i>Ch</i> should be a value of 0 ~ 7.
Return Value	The status (TRUE or FALSE) of the specified DI channel.
Usage	BYTE ch=3; //DI channel #3 BOOL DIChValue = DIReadLine(ch); //read DI channel #3

DIReadPort

Syntax	WORD DIReadPort(void);
Description	Read the entire isolated digital input port (8 channels).
Parameter	None
Return Value	A WORD value (0~255) indicates the status of DI port (8 DI channels).
Usage	WORD DIPortValue = DIReadPort ();

DOWriteLine

Syntax	void DOWriteLine(BYTE ch, BOOL value);
Description	Write a single channel of isolated digital output.
Parameter	<p>ch BYTE value specifies the DO channel to be written. <i>Ch</i> should be a value of 0 ~ 7.</p> <p>value BOOL value (TRUE or FALSE) specifies the status of DO channel.</p>
Return Value	None
Usage	<pre> BYTE ch=3; //DI channel #3 BOOL DOChValue=TRUE; DOWriteLine(ch, DOChValue); //write DO channel #3 as TRUE </pre>

DOWritePort

Syntax	void DOWritePort(WORD value);
Description	Write the entire isolated digital output port (8 channels).
Parameter	<p>value WORD value specifies the status of the DO port. <i>Value</i> should be a value of 0~255.</p>
Return Value	None
Usage	<pre> WORD DOPortValue=0XFF; //11111111b DOWritePort(DOPortValue); //write DO port as 11111111b </pre>